

Agilent 1168/9A Differential and Single-Ended Probes

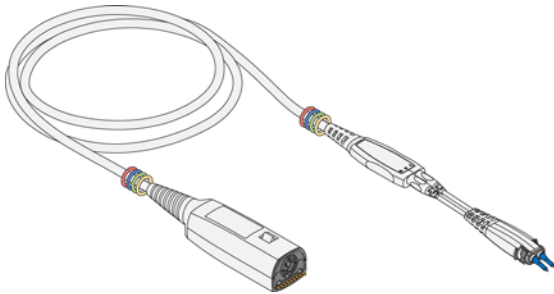

User's Guide



Agilent Technologies

Notices

© Agilent Technologies, Inc. 2014

No part of this manual may be reproduced in any form or by any means (including electronic storage and retrieval or translation into a foreign language) without prior agreement and written consent from Agilent Technologies, Inc. as governed by United States and international copyright laws.

Manual Part Number

01169-97018

Edition

April 2014

Designed in USA

Agilent Technologies, Inc.

Oscilloscope Products Division

Warranty

The material contained in this document is provided "as is," and is subject to being changed, without notice, in future editions. Further, to the maximum extent permitted by applicable law, Agilent disclaims all warranties, either express or implied, with regard to this manual and any information contained herein, including but not limited to the implied warranties of merchantability and fitness for a particular purpose. Agilent shall not be liable for errors or for incidental or consequential damages in connection with the furnishing, use, or performance of this document or of any information contained herein. Should Agilent and the user have a separate written agreement with warranty terms covering the material in this document that conflict with these terms, the warranty terms in the separate agreement shall control.

Technology Licenses

The hardware and/or software described in this document are furnished under a license and may be used or copied only in accordance with the terms of such license.

Restricted Rights Legend

If software is for use in the performance of a U.S. Government prime contract or subcon-

tract, Software is delivered and licensed as "Commercial computer software" as defined in DFAR 252.227-7014 (June 1995), or as a "commercial item" as defined in FAR 2.101(a) or as "Restricted computer software" as defined in FAR 52.227-19 (June 1987) or any equivalent agency regulation or contract clause. Use, duplication or disclosure of Software is subject to Agilent Technologies' standard commercial license terms, and non-DOD Departments and Agencies of the U.S. Government will receive no greater than Restricted Rights as defined in FAR 52.227-19(c)(1-2) (June 1987). U.S. Government users will receive no greater than Limited Rights as defined in FAR 52.227-14 (June 1987) or DFAR 252.227-7015 (b)(2) (November 1995), as applicable in any technical data.

Instrument Markings



The CE mark is a registered trademark of the European Community. ISM GRP 1-A denotes the instrument is an Industrial Scientific and Medical Group 1 Class A product. ICES/NMB-001 indicates product compliance with the Canadian Interference-Causing Equipment Standard.



This product complies with the WEEE Directive (2002/96/EC) marking requirements. The affixed label indicates that you must not discard this electrical/electronic product in domestic household waste. Product Category: With reference to the equipment types in the WEEE Directive Annex I, this product is classed as a "Monitoring and Control instrumentation" product. Do not dispose in domestic household. To return unwanted products, contact your local Agilent office, or refer to Agilent Technologies for more information.



This symbol indicates the Environmental Protection Use Period (EPUP) for the product's toxic substances for the China RoHS requirements.

Safety Notices

CAUTION. A **CAUTION** notice denotes a hazard. It calls attention to an operating procedure, practice, or the like that, if not correctly performed or adhered to, could result in damage to the product or loss of important data. Do not proceed beyond a **CAUTION** notice until the indicated conditions are fully understood and met.

WARNING. A **WARNING** notice denotes a hazard. It calls attention to an operating procedure, practice, or the like that, if not correctly performed or adhered to, could result in personal injury or death. Do not proceed beyond a **WARNING** notice until the indicated conditions are fully understood and met.

Contents

1 Getting Started

- Introduction 8
- Supplied Accessories 12
- Optional Probe Heads with Supplied Accessories 13
- Optional E2669A Differential Connectivity Kit and Accessories 15
- Other Available Accessories 17
- Probe Handling 25
- Using the Velcro Dots 30
- Using Offset With InfiniiMax Active Probes 31
- Slew Rate Requirements for Different Technologies 33
- Safety Information 34
- Service 37

2 Using Probe Heads

- Recommended Configurations 42
- Soldering a ZIF Tip to a DUT 78
- Using N2884A Fine-Wire ZIF tips 83
- N2887A/8A Soft Touch Probe Heads 94

3 Maintaining Probe Heads

- N5381/2A Probe Heads 104
- N5451A Long-Wired ZIF Tips 109
- E2677A/9A Solder-In Probe Heads 113

4 Calibrating Probes

- DC Gain and Offset Calibration 120
- Calibration for Solder-In and Socketed Probe Heads 121
- Calibration for Hand-Held Browser Probe Heads 129
- N2887A & N2888A Calibration and Deskew Procedure 131

5 Characteristics and Specifications

- General 136

InfiniiMax II Series with N5380B SMA Probe Head	139
Environmental	141
Probe Dimensions	142

6 Performance Plots

N5380B SMA Probe Head (Full BW)	148
N5380B SMA Probe Head with the 1134A InfiniiMax Probe	151
N5381A & N5382A Differential Probe Heads (Full BW)	152
N5381A Differential Solder-in Probe Head with 2x Longer Wires	156
N5425A ZIF Probe Head (Full BW)	157
N5425A ZIF Probe Head with N5451A Long-Wired ZIF Tip	161
N5426A ZIF Probe Tip Impedance	176
E2675A Differential Browser	177
E2676A Single-Ended Browser	180
E2677A Differential Solder-in Probe Head (High BW)	183
E2678A Differential Socketed Probe Head (High BW)	186
E2678A Differential Socketed Probe Head w/ Damped Wire	189
E2679A Single-Ended Solder-In Probe Head (High BW)	192
N2887A/N2888A Soft Touch Probe Heads	194

7 Performance Verification

To Test Bandwidth	198
To Test Input Resistance	209
Performance Test Record	214

8 SPICE Models

N5381A and N5382A Heads	217
N5425A ZIF Head with N5426A ZIF Tip Attached	220
N5426A ZIF Tip	223
N5425A ZIF Head with N5451A Long-Wire ZIF Tip	226
N2887A/N2888A Heads	235
InfiniiMax I Heads	238

9 Replacement Parts

E2675A Differential Browser Probe Head	250
E2677A Differential Solder-In Probe Head	250
E2678A Differential Socketed Probe Head	251
E2679A Single-Ended Solder-in Probe Head	252

N5381A and N5382A Probe Heads 252
Other Accessories 253

Contents

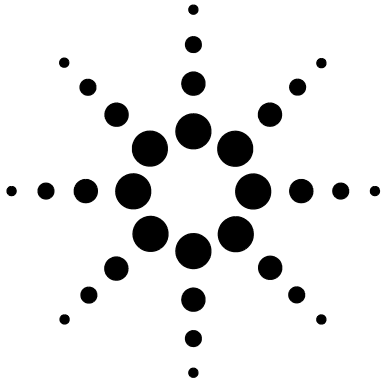

1 Getting Started

Introduction	8
Supplied Accessories	12
Optional Probe Heads with Supplied Accessories	13
Optional E2669A Differential Connectivity Kit and Accessories	15
Other Available Accessories	17
Probe Handling	25
Using the Velcro Dots	30
Using Offset With InfiniiMax Active Probes	31
Slew Rate Requirements for Different Technologies	33
Safety Information	34
Service	37

With the 1168A (10 GHz) and 1169A (12 GHz) probes, you can probe differential and single-ended signals. The probes provide a large common mode range for measuring differential signals and a large offset range for measuring single-ended signals. These probes are used at extreme frequencies where off-board lead resistors cause undesirable response variation. As a result, the 1168A and 1169A probes were designed using resistor-at-the-tip technology where resistors are located onto the very edge of the probe tip board. The wires or probe tips in front of the resistors are long enough to allow easy connection but are short enough that any resonances caused by them are out of band and don't impact the input impedance.



Introduction

Before you can use the probe, you must connect one of the available probe heads to an 1168/9A probe amplifier.

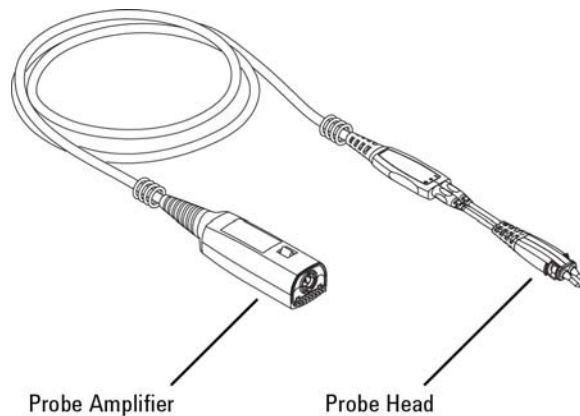

Figure 1 Probe Amplifier with Attached Head

Probe Heads

[Figure 2](#) on page 9 shows the available probe heads and accessories. Four different InfiniiMax II probe heads can be used including a Zero Insertion Force (ZIF) probe head that uses a ZIF tip that can be installed at many locations on your DUT. The ZIF tip's small size is critical in probing tight locations and the ZIF feature allows connection without compressing the delicate wires which cannot support this compression. You can also use the probe amplifiers with the InfiniiMax I probe heads (with some limitations).

The differential probe heads offer easy measurement of differential signals and greatly improve the measurement of single-ended signals.

Each available probe head is documented in [Chapter 2](#), “Using Probe Heads”.

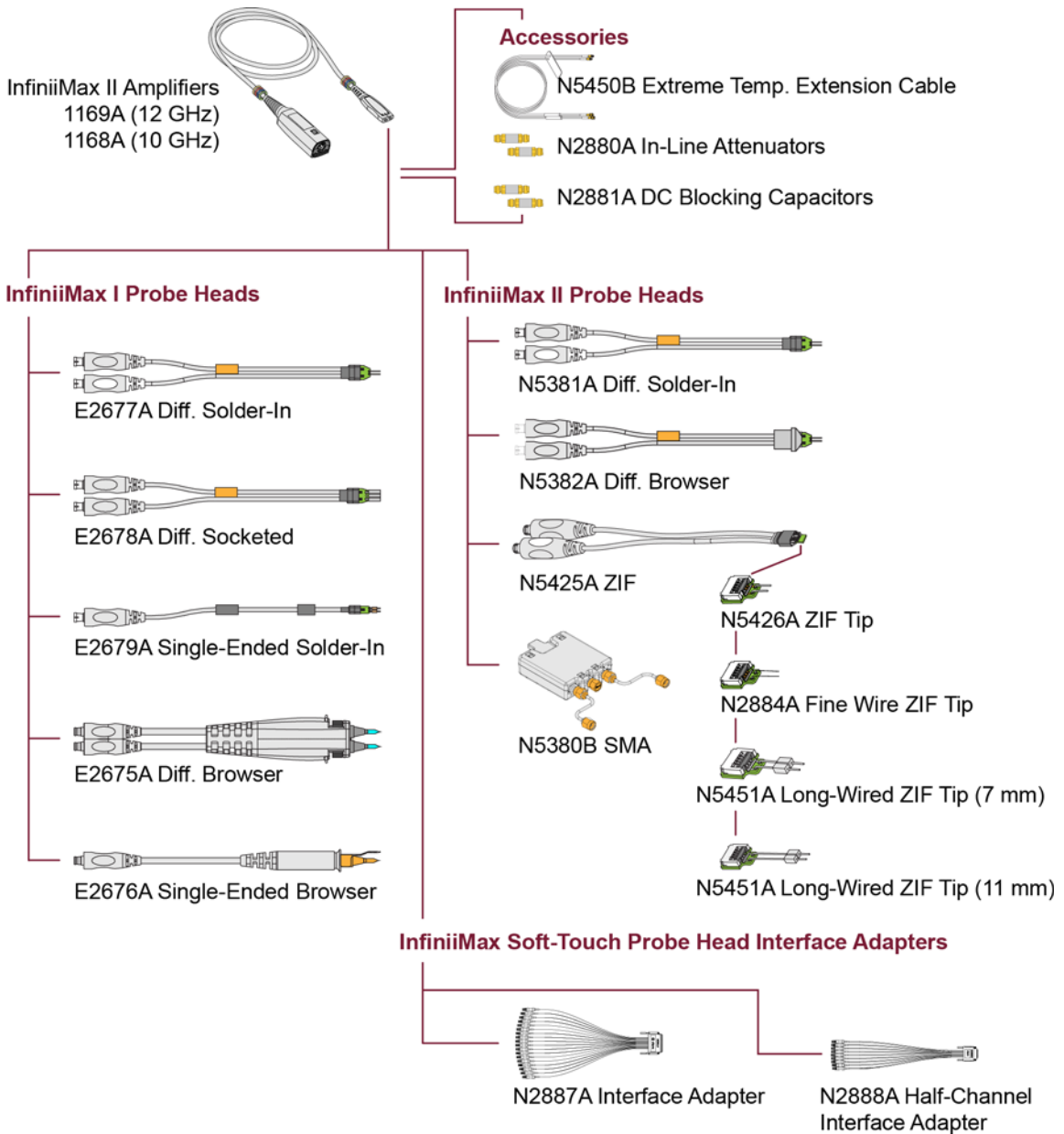

Figure 2 Available Probe Heads

These probes can also be used with the 1143A external power supply.

CAUTION

Before using the probes, refer to “Probe Handling” on page 25.

WARNING

Before using the probe, refer to “Safety Information” on page 34.

Compatible Oscilloscopes

Is Your Oscilloscope Software Up-to-Date?

Agilent periodically releases software updates to support your probe, fix known defects, and incorporate product enhancements. To download the latest firmware, go to Agilent Technologies and search for your oscilloscope’s topic. Click on the “Drivers, Firmware & Software” tab.

Table 1 Compatible Infiniium Oscilloscopes

Oscilloscope	Model
90000 X-, and Q-Series ^a	all
90000A Series	all
86100C/D Series ^b	all
80000B Series	all

a N5442A adapter required.

b N1022A/B adapter required.

Cleaning the probe

If the probe requires cleaning, disconnect it from the oscilloscope and clean it with a soft cloth dampened with a mild soap and water solution. Make sure the probe is completely dry before reconnecting it to the oscilloscope.

Channel Identification Rings

When multiple probes are connected to the oscilloscope, use the channel identification rings to associate the channel inputs with each probe. Place one colored ring near the probe’s channel connector and place an identical color ring near the probe head.

Inspecting the Probe

- Inspect the shipping container for damage.

Keep the damaged shipping container or cushioning material until the contents of the shipment have been checked for completeness and the probe has been checked mechanically and electrically.

- Check the accessories.
- If the contents are incomplete or damaged, notify your Agilent Technologies Sales Office.
- Inspect the probe. If there is mechanical damage or defect, or if the probe does not operate properly or pass calibration tests, notify your Agilent Technologies Sales Office.

If the shipping container is damaged, or the cushioning materials show signs of stress, notify the carrier as well as your Agilent Technologies Sales Office. Keep the shipping materials for the carrier's inspection. The Agilent Technologies office will arrange for repair or replacement at Agilent Technologies' option without waiting for claim settlement.

Supplied Accessories

Figure 3 shows the accessories that are shipped with the 1168/9A probe amplifiers. The probe amplifiers do not come with a probe head *unless* selected at the time of order. Any head shown in Figure 2 on page 9 can be ordered at any time for the probes.

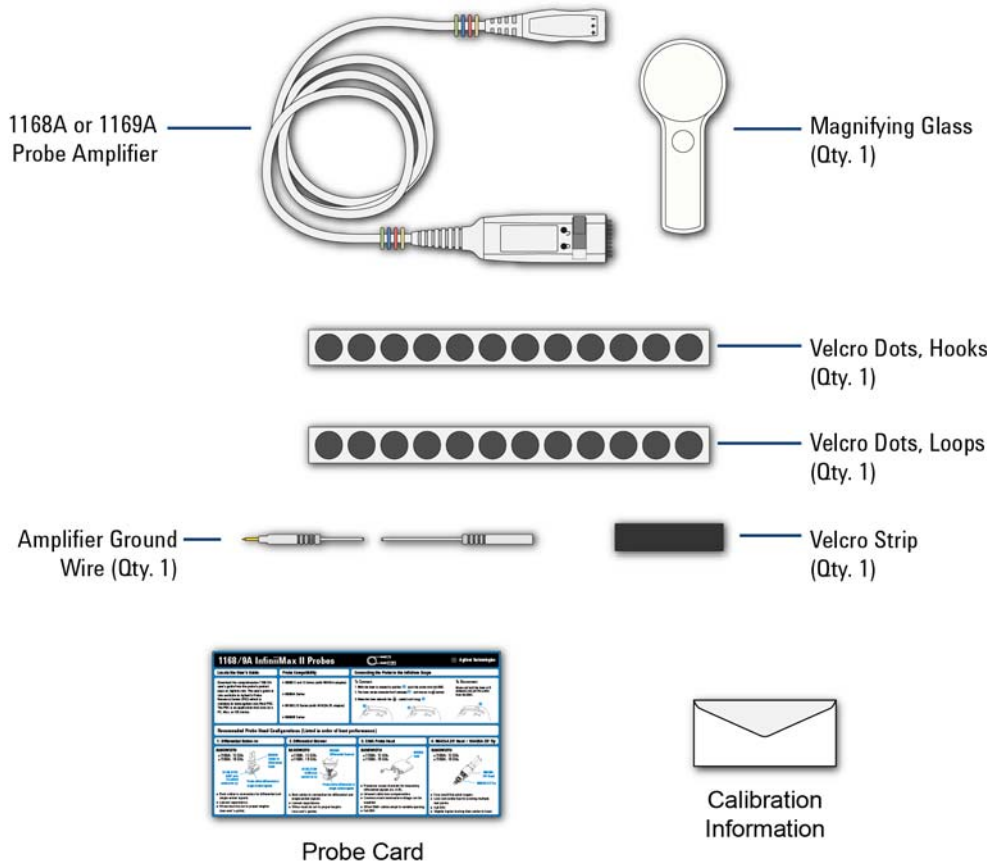
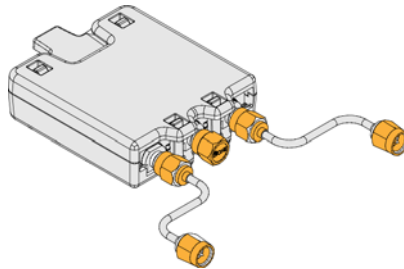

Figure 3 Accessories Supplied With the Probe Amplifier

Optional Probe Heads with Supplied Accessories

The following optional InfiniiMax II probe heads (with accessories) can be ordered at the same time as 1168/9A probe amplifiers. The E2669A connectivity kit, described on [page 15](#) conveniently packages multiple InfiniiMax I probe heads and their accessories.

N5380B SMA Probe Head There are no accessories supplied with this probe head.



N5381A Differential Solder-In Probe Head

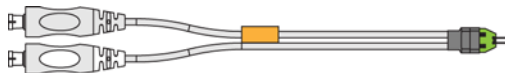

Table 2 Supplied Accessories

Description	Qty Supplied	Part Identification ^a
0.007 tin-plated nickel wire and trim gauge	1	01169-81301
0.005 tin-plated nickel wire and trim gauge	1	01169-21306

^a Allows you to identify the accessory container in the probe case. Not orderable.

1 Getting Started

Optional Probe Heads with Supplied Accessories

N5382A Differential Browser Probe Head

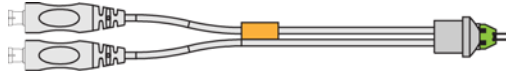

Table 3 Supplied Accessories

Description	Qty Supplied	Part Identification ^a
0.005 steel wire and trim gauge	1	01169-21304

^a Allows you to identify the accessory container in the probe case. Not orderable.

N5425A ZIF Probe Head and N5426A ZIF Tip

There are no accessories supplied with the N5425A or N5426A.



N5425A ZIF

N5426A ZIF Tip

Optional E2669A Differential Connectivity Kit and Accessories

The E2669A differential connectivity kit provides multiple quantities of the three InfiniiMax I probe heads as shown in Figure 4. These probe heads allow full bandwidth probing of differential and single-ended signals. The kit can be ordered at the same time as 1168/9A probe amplifiers.

E2678A Differential Socketed
(quantity 2)

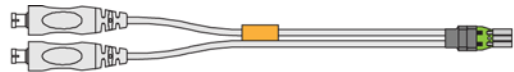

E2677A Differential Solder-In
(quantity 4)

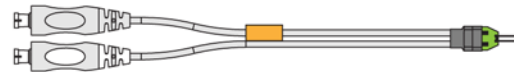

E2675A Differential Browser
(quantity 1)

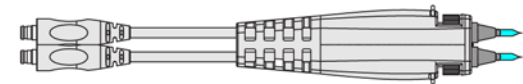

Figure 4 E2669A Differential Connectivity Kit (*not to scale*)

Table 4 Supplied Accessories (Sheet 1 of 2)

Description	Qty Supplied	Used With			Part Number ^a
		E2678A	E2677A	E2675A	
E2678A Differential Socketed Head	2		—		—
E2677A Differential Solder-In Head	4		—		—
E2675A Differential Browser	1		—		—
160Ω damped wire accessory	12	✓			01130-21302
82Ω resistor for full bandwidth	96	✓			01130-81506
Socket for 25 mil (25/1000 inch) square pins, female on both ends	8	✓			01131-85201

1 Getting Started
 Optional E2669A Differential Connectivity Kit and Accessories

Table 4 Supplied Accessories (Sheet 2 of 2)

Description	Qty Supplied	Used With			Part Number ^a
		E2678A	E2677A	E2675A	
25 mil female socket w/20 mil round male pin on other end	8	✓			01131-85202
Heat shrink socket accessory	8	✓			01130-41101
Header adapter, 91Ω	4	✓			01130-63201
82Ω resistor template	1	✓			01131-94309
91Ω resistor for full bandwidth	80		✓		0700-2353
150Ω resistor for medium bandwidth	40		✓		0700-2350
91Ω resistor template	1		✓		01131-94311
150Ω resistor template	1		✓		01131-94308
Resistive tip (blue), 91Ω	20			✓	01131-62102
Ergonomic handle	1			✓	01131-43201

a Not orderable.

Other Available Accessories

This section contains information on the following accessories:

N5450B Extreme Temp Cable Extension Kit 17

N2880A InfiniiMax In-Line Attenuator Kit 20

N2881A InfiniiMax DC Blocking Capacitors 23

N5450B Extreme Temp Cable Extension Kit

The extreme temperature cable extension kit is an accessory that allows an oscilloscope probe to be used to monitor a device in a temperature chamber. Agilent's Infiniimax probe amplifiers have a specified operating temperature range from 5° C to 40° C, but the probe heads can be operated over a much larger range of temperatures.

Use the extension cables to physically separate the amplifier from the probe head which allows you to operate the probe head inside a temperature chamber while the probe amplifier remains outside the chamber.

To ensure a high-quality measurement, the N5450B cable set have been phase-matched at the factory. A coupling tag is included with the cables to ensure the cables stay as a matched pair. To install the coupling tag, slip the small end of each cable through the holes in the tag. The tag can be positioned anywhere along the length of the cable and can withstand the temperature ranges specified.



1 Getting Started

Other Available Accessories

Table 5 Probing Temperature Ranges

Probe Head Configuration ^a	Temperature Range (°C)	Average Lifetime of the Probe Head (cycles) ^b
N5381A	-55° to +150°	> 250
E2677A	-25° to +80°	> 1000
E2678A		
N5425A + N5426A		
N5451A		

a Refers to the probe head or tip that is attached to the cable extension kit.

b A cycle is defined to be a temperature sweep from either -55° C to 150° C and then back to -55° C or from -25° C to 80° C and then back to -25° C depending upon the probe head configuration being used.

CAUTION

Avoid rapid changes in temperature that can lead to moisture accumulating in the form of condensation on the probe components, as well as the DUT. If this occurs, wait until the moisture has evaporated before making any measurements.

CAUTION

Additional care must be taken when handling probe heads used during extreme temperature cycling because this process makes the probe heads less robust.

CAUTION

Secure the ends of the extension cable near the probe head in the temperature chamber such that the probe head legs are not tugged or moved around significantly.

CAUTION

Prevent abrasion and tears in the cable's jacket, do not rest the extension cables on any metal objects or objects with sharp edges.

CAUTION

Do not kink the cables. The cables are designed to be flexible, but are not designed to be bent sharply.

NOTE

Keep your extreme temperature testing probes separate from the probes they use under milder conditions. This is because cycling probe heads through extreme temperature ranges has a marked affect on their lifetimes as listed in [Table 5](#). Only the lifetime of the probe head is affected by temperature cycling. The extension cables and probe amplifier should not need to be replaced with extended temperature cycling.

NOTE

Discoloration or texture changes are possible with the extension cables. These changes do not, however, affect the performance or the quality of a measurement.

1 Getting Started

Other Available Accessories

N2880A InfiniiMax In-Line Attenuator Kit

The in-line attenuators are an accessory for the probes. The dynamic range of the 1168A/9A probes are $3.3 V_{p-p}$. If you need to measure larger signals, the probe's design allows you to add the N2880A InfiniiMax in-line attenuators between the probe head and the probe amplifier to increase the dynamic range. The N2880A provides two each of 6 dB, 12 dB, and 20 dB attenuators. The attenuators come as matched pairs and should only be used with each other. If you look on each attenuator, you will see a serial number. The pair of matching attenuators in each set will have the same four digit numeric prefix and will differ by the last letter (one attenuator in the matched pair will be labeled A and the other will be labeled B).

Additionally, these attenuators enable you to increase the offset range of the probe as described in [Table 6](#) on page 21. When using the N2880A In-Line Attenuators, the bandwidth and rise time of your probing system is not affected. There is, however, a trade-off in noise (refer to [Table 6](#)) and in the accuracy of DC offset relative to the input.



The maximum input voltage of the InfiniiMax probe heads is $\pm 30 V_{dc}$ and so they should not be used to measure signals that exceed this range. This places a practical limit of 20 dB on the attenuators used with the InfiniiMax probing system. Larger attenuation ratios will only degrade the noise performance and gain of the system.

All InfiniiMax probe heads and amplifiers are compatible with the N2880A In-line attenuators. However, due to the N5380B dual-SMA probe head's maximum input voltage

specification of 2.28 V_{RMS}, the N5380B is not suitable for measuring signals large enough to require an added attenuator.

Table 6 N2880A With 1168A/9A Probe Amplifiers

Added Attenuator	Dynamic Range	Offset Range	Typical Noise Referred to	Maximum Allowed Input Slew Rate ^a (se = single-ended) (diff = differential)	Nominal DC Attenuation of Probe System
None	3.3 Vp-p	±16V	2.2 mV RMS	se: 25 V/ns, diff: 40 V/ns	3.45:1
6 dB (2:1)	6.6 Vp-p	±30 V ^b	6.3 mV RMS	se: 50 V/ns, diff: 80 V/ns	6.9:1
12 dB (4:1)	13.2 Vp-p	±30 V ^b	13.2 mV RMS	se: 100 V/ns, diff: 160 V/ns	13.8:1
20 dB (10:1)	33.3 Vp-p	±30 V ^b	33.4 mV RMS	se: 250 V/ns, diff: 400 V/ns	34.5:1

- a These slew rate do not apply when the N5380B SMA probe head is used with the InfiniiMax amplifiers.
 b The actual range of DC voltage for these attenuators is greater than ±30 V, but the usable range of DC voltage at the probe input is limited to ±30 Vdc.

NOTE The values shown above do not apply to the N5380B dual-SMA probe head. Due to the maximum input voltage specification of 2.28 VRMS for the N5380B, it is not suitable for measuring signals large enough to require an added attenuator.

Frequency Response Plots

Below are the frequency response plots for four setups: the probe without any attenuators, the probe with the 6 dB attenuators, the probe with the 12 dB attenuators, and the probe with the 20 dB attenuators.

1 Getting Started

Other Available Accessories

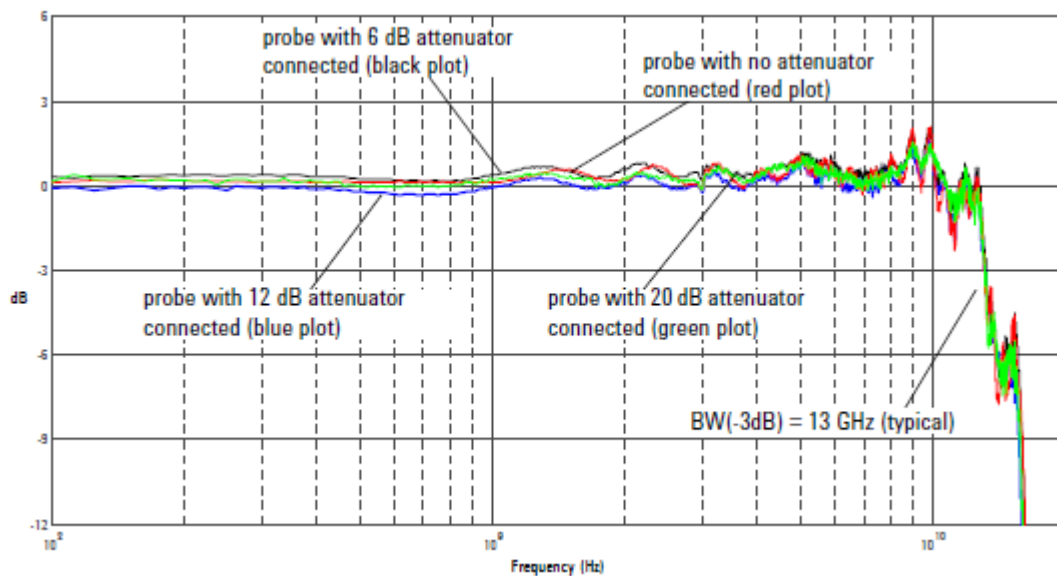

Red = $\text{dB}(V_{\text{out}}/V_{\text{in}}) + 10.8 \text{ dB}$ of probe

Black = $\text{dB}(V_{\text{out}}/V_{\text{in}}) + 6\text{dB}$ attenuator + 10.8 dB

Blue = $\text{dB}(V_{\text{out}}/V_{\text{in}}) + 12 \text{ dB}$ attenuator + 10.8 dB of probe

Green = $\text{dB}(V_{\text{out}}/V_{\text{in}}) + 20 \text{ dB}$ attenuator + 10.8 dB of probe

Figure 5 Frequency Response

The software in the Infiniium oscilloscopes will detect a probe when it is connected and by default will assume that no additional attenuators are installed. If you want to scale readings and settings on the oscilloscope so they are correct with the attenuators installed, refer to the procedures below for your specific oscilloscope series.

Calibrating Attenuators on an Infiniium Series Oscilloscope

You cannot calibrate your Infiniium probes with the attenuators attached. Calibrate the Infiniium probes as you normally would (with no attenuators), configure the attenuators as discussed in the next section, and begin probing.

Configuring Attenuators on an Infiniium Series Oscilloscope

First, plug your Infiniium probe amplifier / probe head into one of the oscilloscope channels with the attenuators connected. Then enter the Probe Setup dialog box (can be reached via **Setup > Probes** on the oscilloscope menu). Press the **Configure Probing System** button. A pop-up window will appear where you can select External Scaling. Click the **Decibel** radio button under the External Scaling section and then set the **Gain** field to either -6 dB, -12 dB, or -20 dB depending on the attenuator you are using (be sure to include the negative sign). Finally, you will need to manually set the **Offset** field in this dialog box to zero out the signal.

N2881A Infiniium DC Blocking Capacitors

The DC blocking capacitors are an accessory for the probes. The architecture of the Infiniium probing system allows you to place the N2881A DC blocking caps in between the probe amplifier and the probe head as shown in Figure 6. The capacitors block out the DC component of the input signal (up to 30 Vdc).



Figure 6 Blocking Caps Between Probe Amplifier and Head

1 Getting Started

Other Available Accessories

You can use the blocking capacitors with the N2880A In-Line Attenuators. The order of the two products in the probing system (that is, which one is closest to the probe amplifier) does not matter.

Figure 7 shows the frequency response plot of the blocking capacitors (no probe included).

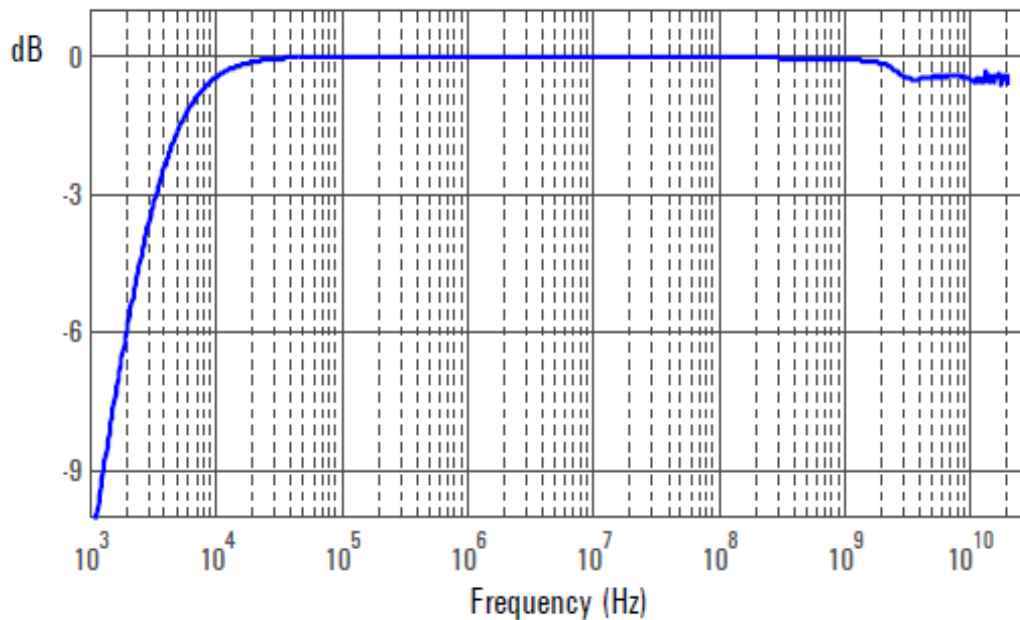

Figure 7 DC Blocking Cap Insertion Loss (S21) versus Frequency (DC Blocking Cap only)

Probe Handling

This probe has been designed to withstand a moderate amount of physical and electrical stress. However, with an active probe, the technologies necessary to achieve high performance do not allow the probe to be unbreakable. Treat the probe with care. It can be damaged if excessive force is applied to the probe tip. This damage is considered to be abuse and will void the warranty when verified by Agilent Technologies service professionals.

- Exercise care to prevent the probe end from receiving mechanical shock.
- Store the probe in a shock-resistant case such as the foam-lined shipping case which came with the probe.

Connecting and Disconnecting Probe Heads

When disconnecting a probe head from an amplifier, pull the probe head connectors straight out of the sockets as shown in [Figure 8](#). When connecting a probe head to an amplifier, push straight in. Always grasp the indentations located on the sides of the amplifier as shown in [Figure 8](#). There are also indentations on many of the probe head sockets so you have a convenient place to grasp there as well.



Figure 8 Properly Pulling the Probe Head Straight Out

1 Getting Started

Probe Handling

CAUTION

Avoid damaging the connection pins. Never bend the probe head in order to “pop” it loose from the amplifier. Do not wiggle the probe head up and down or twist it to remove the connectors from the sockets.

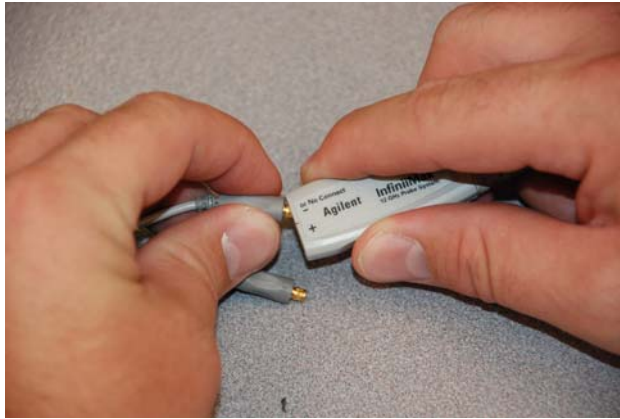

Figure 9 Improperly Disconnecting a Probe Head From an Amplifier

Handling the Probe Cable

CAUTION

Avoid degrading the probe’s performance. Do not twist, kink, or tightly bend the probe’s cable.

CAUTION

When the probe is attached to an oscilloscope, avoid letting object hit the probe cable where the cable exits the probe amplifier and bend it well beyond its limit.

When storing the probe, coil the cable in a large loops and avoid twisting the cable. Coil the cable in a similar manner to how garden hoses or extension cords are typically coiled. You can start by wrapping the cable around your thumb as shown in [Figure 10](#). Then continue to circle your thumb, but provide a slight twist with each rotation. This allows the cable rotations to lie flat against each other and will eliminate the net twisting of the cable in the end.



Figure 10 Recommended Coil for Storage

CAUTION



Make the coil's radius fairly large so it does not induce kinking or bending.

Handling the Probe Amplifier

The probe amplifier contains a delicate circuit board. Treat it carefully and take standard precautions (for example, not dropping it repeatedly or from large heights, not getting it wet, not smashing it with heavy objects, etc.). These probes are sensitive ESD devices so standard precautions need to be used to not ruin the probe from the build-up of static charges.

Connecting the Probe to an Oscilloscope

The probes are only meant to be plugged into gold plated BNCs (like those on Infiniium oscilloscopes). To connect the probe to the oscilloscope, do the following steps:

- 1 As shown in Figure 11, with the lever in the relaxed position ① push the probe onto the BNC. The lever moves towards the **R** (release) ② and returns to the  symbol.
- 2 Move the lever towards the  symbol until snug. ③

NOTE

How far the locking mechanism can be pushed to the right varies and will not be the same for every user. Therefore, do not try to force it further to the right because you believe it is unlocked. Instead, gently push it until it is snug.

To disconnect the probe, move and hold the lever at **R** (release) ② and pull the probe from the BNC.



Figure 11 Properly Connecting a Probe to the Oscilloscope

Securing Probe Heads and Amplifiers to Your DUTs

When soldering a probe head to a circuit, first provide strain relief by using low temperature hot glue (use as little as possible) or non-conductive double-sided tape. Do not use super glue and do not get the low temperature hot glue on the actual probe head tip as this can damage the precision components of your probing system (only use the low temperature hot glue on the probe head cables). The provided velcro pads can be used to secure your probe amplifier casing to the board.

Once strain relief has been provided, solder the probe tip to the circuit board and then plug the probe head into the probe amplifier.

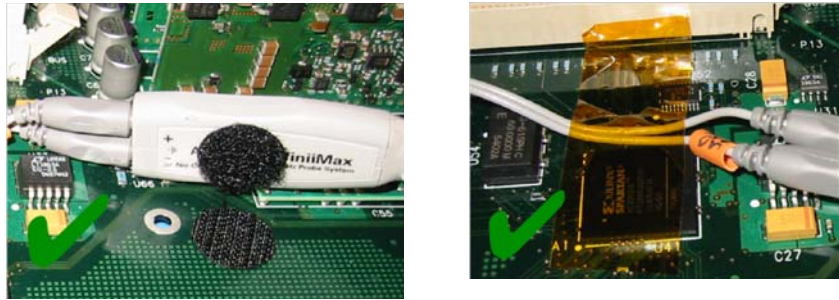

Figure 12 Correct Securing Methods

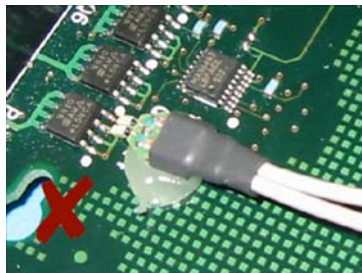

Figure 13 Incorrect Securing Method Because Glue is Placed on the Probe Head Tip

Using the Velcro Dots

The velcro dots can be used to secure the probe amplifier to a circuit board removing the weight of the probe from the circuit connection. Attach a Velcro dots to both the probe amplifier and the circuit board as shown in [Figure 14](#) on page 30.

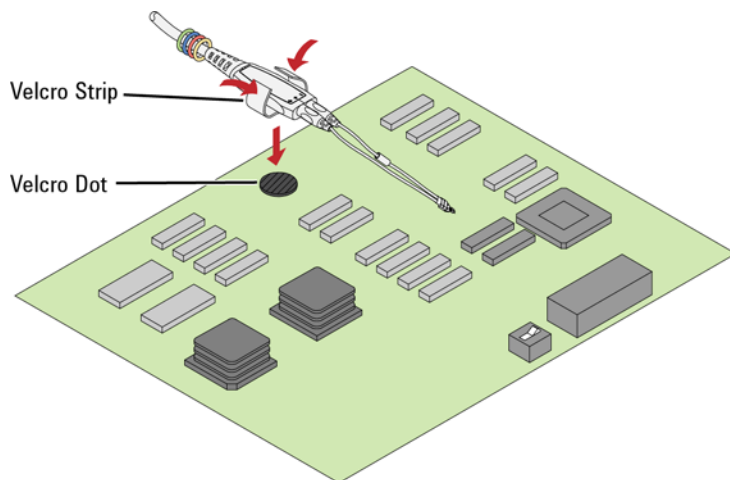

Figure 14 Using the Velcro Dots

Using Offset With InfiniiMax Active Probes

It is important to understand how the 113xA probes behave with respect to offset when different probe head / signal combinations are used.

The purpose of offset in active probes or oscilloscope front ends is to allow the subtraction of most or all of the dc component of the input signal so the signal can better utilize the dynamic range of the input. When using an InfiniiMax probe with an Infiniium oscilloscope, you can select the case (see the three cases described below) that applies for your measurement by selecting the **Probes** button under the channel setup menu. This allows you to select which type of probe head is being used and, if it is a differential probe head, allows you to select whether you are probing a differential or single-ended signal. With these inputs, the oscilloscope will use the proper type of offset for your measurement case. The specifics for each case are discussed below.

When adjusting the offset for a particular probe head, make sure to have a triggered signal.

Case 1. A single-ended probe head probing a single-ended signal

For this case, the offset control on the oscilloscope controls the probe offset and the channel offset is set to zero. This allows the offset voltage to be subtracted from the input signal before the signal gets to the differential amplifier. Since this subtraction is done before any active circuits, the offset range is large ($\pm 16V$). Note that the minus probe tip is not present when using a single-ended probe head which means nothing is plugged into the "-" input of the probe amp. This is normal and causes no problems.

Case 2. A differential probe head probing a single-ended signal

For this case, the offset control on the oscilloscope controls the probe offset and the channel offset is set to zero. This allows the offset voltage to be subtracted from the input

1 Getting Started

Using Offset With InfiniiMax Active Probes

signal before the signal gets to the differential amplifier. Since this subtraction is done before any active circuits, the offset range is large ($\pm 16V$). A differential probe can make higher bandwidth and more accurate measurements on single-ended signals than a single-ended probe and this method of applying offset to only the plus side of a differential probe means there is no sacrificing of offset range.

Case 3. A differential probe head probing a differential signal

For this case, the offset control on the oscilloscope controls the oscilloscope channel offset. The probe offset is not used and set to zero. Since the plus and minus sides of differential signals have the same dc component, it will be subtracted out and the output of the probe will by definition be centered around ground.

The channel offset allows the waveform seen on screen to be moved as desired. The allowable dc component in the plus and minus signals is determined by the common mode range of the probe.

Slew Rate Requirements for Different Technologies

The following table shows the slew rates for several different technologies. The maximum allowed input slew rate is 25 V/ns for single-ended signals and 40 V/ns for differential signals. Table 7 shows that the maximum required slew rate for the different technologies is much less than that of the probe.

Table 7 Slew Rate Requirements

Name of Technology	Differential Signal	Max Single-Ended Slew Rate ^a (V/ns)	Max Differential Slew Rate ^b (V/ns)	Driver Min Edge Rate (20%-80% ps)	Max Transmitter Level (Diff V)
PCI Express (3GIO)	YES	9.6	19.2	50	1.6
RapidIO Serial 3.125Gb	YES	8.0	16.0	60	1.6
10GbE XAUI (4x3.125Gb)	YES	8.0	16.0	60	1.6
1394b	YES	8.0	16.0	60	1.6
Fibre Channel 2125	YES	8.0	16.0	75	1
Gigabit Ethernet 1000Base-CX	YES	7.8	15.5	85	2.2
RapidIO 8/16 2Gb	YES	7.2	14.4	50	1.2
Infiniband 2.5Gb	YES	4.8	9.6	100	1.6
HyperTransport 1.6Gb	YES	4.0	8.0	113	1.5
SATA (1.5Gb)	YES	1.3	2.7	134	0.6
USB 2.0	YES	0.9	1.8	375	1.1
DDR 200/266/333	NO	7.2	n/a	300	3.6
PCI	NO	4.3	n/a	500	3.6
AGP-8X	NO	3.1	n/a	137	0.7

a The probe specification is 25 V/ns

b The probe specification is 40 V/ns

Safety Information



This manual provides information and warnings essential for operating this probe in a safe manner and for maintaining it in safe operating condition. Before using this equipment and to ensure safe operation and to obtain maximum performance from the probe, carefully read and observe the following warnings, cautions, and notes.

This product has been designed and tested in accordance with accepted industry standards, and has been supplied in a safe condition. The documentation contains information and warnings that must be followed by the user to ensure safe operation and to maintain the product in a safe condition.

Note the external markings on the probe that are described in this document.

To avoid personal injury and to prevent fire or damage to this product or products connected to it, review and comply with the following safety precautions. Be aware that if you use this probe assembly in a manner not specified, the protection this product provides may be impaired.

WARNING

Use Only Grounded Instruments.

Do not connect the probe's ground lead to a potential other than earth ground. Always make sure the probe and the oscilloscope are grounded properly.

WARNING

Connect and Disconnect Properly.

Connect the probe to the oscilloscope and connect the ground lead to earth ground before connecting the probe to the circuit under test. Disconnect the probe input and the probe ground lead from the circuit under test before disconnecting the probe from the oscilloscope.

WARNING

Observe Probe Ratings.

Do not apply any electrical potential to the probe input which exceeds the maximum rating of the probe. Make sure to comply with the voltage versus frequency derating curve found in this manual.

WARNING

Indoor Use Only.

Do not operate in wet/damp environments. Keep product surfaces dry and clean.

WARNING

Do Not Operate With Suspected Failures. Refer to qualified service personnel.

WARNING

Never leave the probe connected to a conductor while it is not connected to an oscilloscope or voltage measuring instrument.

WARNING

Do not use a probe which is cracked, damaged or has defective leads.

WARNING

Do not install substitute parts or perform any unauthorized modification to the probe.

WARNING

Do not operate the probe or oscilloscope in the presence of flammable gasses or fumes. Operation of any electrical instrument in such an environment constitutes a definite safety hazard.

WARNING

Do not use the probe or oscilloscope in a manner not specified by the manufacturer.

WARNING

Service instructions are for trained service personnel. To avoid dangerous electric shock, do not perform any service unless qualified to do so. Do not attempt internal service or adjustment unless another person, capable of rendering first aid and resuscitation, is present.

CAUTION

The probe cable is a sensitive part of the probe and, therefore, you should be careful not to damage it through excessive bending or pulling. Avoid any mechanical shocks to this product in order to guarantee accurate performance and protection.

Concerning the Oscilloscope or Voltage Measuring Instrument to Which the Probe is Connected

WARNING

Whenever it is likely that the ground protection is impaired, you must make the instrument inoperative and secure it against any unintended operation.

WARNING

If you energize the instrument by an auto transformer (for voltage reduction or mains isolation), the ground pin of the input connector terminal must be connected to the earth terminal of the power source.

WARNING

Before turning on the instrument, you must connect the protective earth terminal of the instrument to the protective conductor of the (mains) power cord. The mains plug shall only be inserted in a socket outlet provided with a protective earth contact. You must not negate the protective action by using an extension cord (power cable) without a protective conductor (grounding). Grounding one conductor of a two-conductor outlet is not sufficient protection.

WARNING

Only fuses with the required rated current, voltage, and specified type (normal blow, time delay, etc.) should be used. Do not use repaired fuses or short-circuited fuse holders. To do so could cause a shock or fire hazard.

WARNING

Capacitors inside the instrument may retain a charge even if the instrument is disconnected from its source of supply.

Service

The following symptoms may indicate a problem with the probe or the way it is used. The probe is a high frequency device with many critical relationships between parts. For example, the frequency response of the amplifier on the hybrid is trimmed to match the output coaxial cable. As a result, to return the probe to optimum performance requires factory repair. If the probe is under warranty, normal warranty services apply.

Probe Calibration Fails

Probe calibration failure with an oscilloscope is usually caused by improper setup. If the calibration will not pass, check the following:

- Check that the probe passes a waveform with the correct amplitude.
- If the probe is powered by the oscilloscope, check that the offset is approximately correct. The probe calibration cannot correct major failures.
- Be sure the oscilloscope passes calibration without the probe.
- Be sure that the probe head that you are using has been in the oscilloscope's Probe Setup dialog box.

Incorrect Pulse Response (flatness)

If the probe's pulse response shows a top that is not flat, check for the following:

- Output of probe must be terminated into a proper 50Ω termination. If you are using the probe with an Infiniium oscilloscope, this should not be a problem. If you are using the probe with other test gear, ensure the probe is terminated into a low reflectivity 50Ω load ($\sim \pm 2\%$).

- If the coax or coaxes of the probe head in use has excessive damage, then reflections may be seen within approximately 1 ns of the input edge. If you suspect a probe head, swap it with another probe head and see if the non-flatness problem is fixed.
- If the one of the components in the tip have been damaged there may be a frequency gain non-flatness at around 40 MHz. If you suspect a probe head, swap it with another probe head and see if the non-flatness problem is fixed.

Incorrect Input Resistance

The input resistance is determined by the probe head in use. If the probe head is defective, damaged, or has been exposed to excessive voltage, the input resistor may be damaged. If this is the case, the probe head is no longer useful. A new probe head will need to be obtained either through purchase or warranty return.

Incorrect Offset

Assuming the probe head in use is properly functioning, incorrect offset may be caused by defect or damage to the probe amplifier or by lack of probe calibration with the oscilloscope.

Returning the Probe for Service

If the probe is found to be defective we recommend sending it to an authorized service center for all repair and calibration needs. Perform the following steps before shipping the probe back to Agilent Technologies for service.

- 1** Contact your nearest Agilent sales office for information on obtaining an RMA number and return address.
- 2** Write the following information on a tag and attach it to the malfunctioning equipment.
 - Name and address of owner
 - Product model number (for example, N2820A)
 - Product Serial Number (for example, MYXXXXXXXX)
 - Description of failure or service required

NOTE

Include probing and browsing heads if you feel the probe is not meeting performance specifications or a yearly calibration is requested.

- 3 Protect the probe by wrapping in plastic or heavy paper.
- 4 Pack the probe in the original carrying case or if not available use bubble wrap or packing peanuts.
- 5 Place securely in sealed shipping container and mark container as "FRAGILE".

NOTE

If any correspondence is required, refer to the product by serial number and model number.

Contacting Agilent Technologies

For technical assistance, contact your local Agilent Call Center.

- In the Americas, call 1 (800) 829-4444
- In other regions, visit <http://www.agilent.com/find/assist>

Before returning an instrument for service, you must first call the Call Center at 1 (800) 829-4444.

1 **Getting Started**
Service

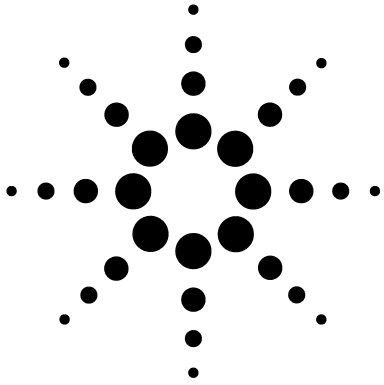

2 Using Probe Heads

Recommended Configurations	42
N5381A Differential Solder-In	46
N5382A Differential Browser	49
N5380B SMA	52
N5425A with N5426A ZIF Tip	55
N5425A with N2884A Fine Wire ZIF Tip	57
N5425A with N5451A Long-Wire ZIF Tip (7 mm)	60
N5425A with N5451A Long-Wire ZIF Tip (11 mm)	62
E2677A Differential Solder-In Probe Head	64
E2678A Differential Socketed Probe Head	66
E2675A Differential Browser	68
E2679A Single-Ended Solder-in Probe Head	71
E2676A Single-Ended Browser	73
E2678A Differential Socketed & Damped Wire Accessory	75
Soldering a ZIF Tip to a DUT	78
Using N2884A Fine-Wire ZIF tips	83
N2887A/8A Soft Touch Probe Heads	94

Performance Graphs

Graphs showing the performance of the heads are shown in [Chapter 6](#).

This chapter describes the probe head configurations listed in the order of the best performance to the least performance. Always refer to the information in this chapter *before* using any probe head. The recommended configurations are designed to give the best probe performance for different probing situations. This allows you to quickly make the measurements you need with confidence in the performance and signal fidelity.



Recommended Configurations

Table 8 Recommended InfiniiMax II Configurations (Sheet 1 of 2)

Recommended Order of Use	BW (GHz)	Cdiff ^a (pF)	Cse ^b (pF)	Usage
N5381A Differential Solder-In (Refer to page 46.)				
1	Full Bandwidth 1168A: >10 1169A: >12	0.21	0.35	Differential and Single-ended signals Solder-in hands free connection Hard to reach targets Very small fine pitch targets Characterization
N5382A Differential Browser (Refer to page 49.)				
2	Full Bandwidth 1168A: >10 1169A: >12	0.21	0.35	Differential and Single-ended signals Hand-held browsing Probe holders General purpose troubleshooting Ergonomic handle available
N5380B SMA (Refer to page 52.)				
3	Full Bandwidth 1168A: >10 1169A: >12	N/A	N/A	Full bandwidth Preserve oscilloscope channels as opposed to using the A minus B mode. Removes inherent cable loss through compensation. Common mode termination voltage can be applied Offset matched sma cables adapt to variable spacing
N5425A ZIF with N5426A ZIF Tip (Refer to page 55.)				
4	Full Bandwidth 1168A: >10 1169A: >12	0.33	0.53	Differential and Single-ended signals Solder-in with ZIF Tip connection Very small fine pitch target Slightly higher loading than solder-in probe head

Table 8 Recommended InfiniiMax II Configurations (Sheet 2 of 2)

Recommended Order of Use	BW (GHz)	C _{diff} ^a (pF)	C _{se} ^b (pF)	Usage
N5425A ZIF with N2884A Fine Wire ZIF Tip (Refer to page 57.)				
5	Full Bandwidth 1168A: >10 1169A: >12	350 fF	—	Differential high fidelity Solder-in fine wire with ZIF Tip connection Extremely small fine pitch target, active ICs Fragile lead wires
N5425A ZIF with N5451A Long Wired ZIF Tip (7 mm resistor length) (Refer to page 60.)				
6	~9.9 (0° span) ^c ~4.4 (60° span) ^d	—	0.6 0.58	Differential and Single-ended signals Solder-in with LW ZIF Tip connection Variable pitch targets, including larger pitches Higher loading than solder-in probe head
N5425A ZIF with N5451A Long Wired ZIF Tip (11 mm resistor length) (Refer to page 62.)				
7	~5 (0° span) ^c ~3.3 (60° span) ^d	—	0.68 0.68	Differential and Single-ended signals Solder-in with LW ZIF Tip connection Variable pitch targets, including larger pitches Higher loading than solder-in probe head

- a Capacitance seen by differential signals
- b Capacitance seen by single-ended signals
- c 0° span between the two LW ZIF resistor leads
- d 60° span between the two LW ZIF resistor leads

Table 9 lists probe head configurations that are available in the E2669A connectivity kit. Not all of these configurations will give the best probe performance of the 1168A and 1169A. The probe configurations are shown in the order of the best performance to the least performance.

2 Using Probe Heads

Recommended Configurations

Table 9 InfiniiMax I Configurations (Sheet 1 of 2)

Recommended Order of Use	BW (GHz)	C _{diff} ^a (pF)	C _{se} ^b (pF)	Usage
E2677A Differential Solder-In (high bandwidth resistors) (Refer to page 64.)				
8	1168A: >10 1169A: >12	0.27	0.44	Differential and Single-ended signals Solder-in hands free connection Hard to reach targets Very small fine pitch targets Characterization
E2678A Differential Socketed (full bandwidth resistors) (Refer to page 66.)				
9	1168A: >10 1169A: >12	0.34	0.56	Differential and Single-ended signals Removable connection using solder-in resistor pins Hard to reach targets
E2675A Differential Browser (Refer to page 68.)				
10	~5.2	0.32	0.57	Differential and Single-ended signals Hand-held browsing Probe holders General purpose troubleshooting Ergonomic handle available
E2679A Single-Ended Solder-In (high bandwidth resistors) (Refer to page 71.)				
11	~5.2	N/A	0.50	Single-ended signals only Solder-in hands free connection when physical size is critical Hard to reach targets Very small fine pitch targets
E2676A Single-Ended Browser (Refer to page 73.)				
12	~6	N/A	0.65	Single-ended signals only Hand or probe holder where physical size is critical General purpose troubleshooting Ergonomic handle available

Table 9 InfiniiMax I Configurations (Sheet 2 of 2)

Recommended Order of Use	BW (GHz)	Cdiff ^a (pF)	Cse ^b (pF)	Usage
E2678A Differential Socketed with Damped Wire Accessories (Refer to page 75.)				
	~1.2	0.63	0.95	Differential and Single-ended signals For very wide spaced targets Connection to 25 mil square pins when used with supplied sockets

- a Capacitance seen by differential signals
- b Capacitance seen by single-ended signals

1 N5381A Differential Solder-In

Full BW
1168A:
>10 GHz
1169A:
>12 GHz



The N5381A allows a soldered connection into a system for a reliable hands-free connection. This probe configuration provides the full bandwidth signals and the lowest capacitive loading for measuring both single-ended and differential signals. It utilizes strong 7 mil (or optional 5 mil) diameter nickel wires, which allow connection to very small, fine pitch targets.

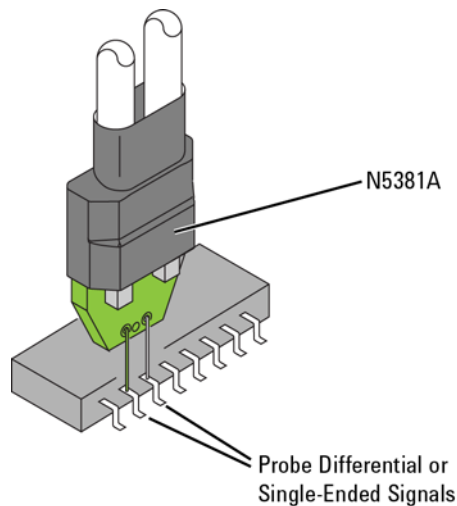

Figure 15 N5381A

Table 10 Supplied Accessories

Accessory	Quantity	Part Number
0.007 inch tin-plated nickel wire	1	01169-81301
0.005 inch tin-plated nickel wire	1	01169-21306
Trim Gauge	1	—



TO INSTALL OR REPAIR THE LEADS. Refer to “N5381/2A Probe Heads” on page 104.

NOTE

For the differential solder-in probe head, the + and – connection can be determined when the probe head is plugged into the probe amplifier, therefore, it does not matter which way the tip is soldered.

CAUTION

Figure 16 shows how to adjust the spacing of the head’s wires without stressing the solder joint. Use tweezers to grab and stabilize the lead near the pc board edge. Then, without moving the tweezers, position the wires as needed. Stabilizing the wire near the solder joint reduces stress at the solder joint. The wires will last much longer with multiple adjustments.

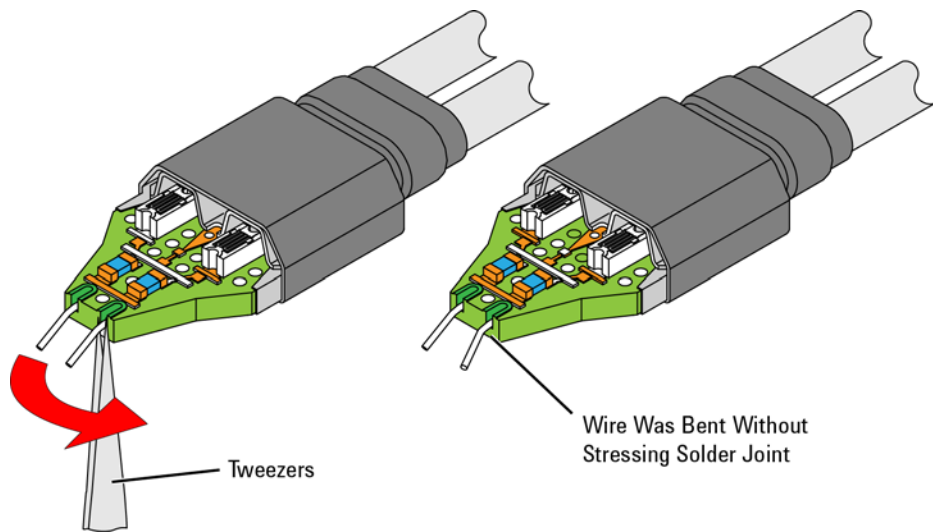

Figure 16 Adjusting Spacing Without Stressing Solder Joint

NOTE

When soldering in leads to the DUT always use plenty of flux. The flux will ensure a good, strong solder joint without having to use an excessive amount of solder.

2 Using Probe Heads

Recommended Configurations

NOTE

Strain relieve the micro coax leading away from the solder-in tips using hook-and-loop fasteners or adhesive tape to protect delicate connections.



PERFORMANCE PLOTS. Refer to “N5381A & N5382A Differential Probe Heads (Full BW)” on page 152.



SPICE MODEL. Refer to “N5381A and N5382A Heads” on page 217.

2 N5382A Differential Browser

Full BW
1168A:
>10 GHz
1169A:
>12 GHz



The N5382A differential hand-held browser is the best choice for general purpose troubleshooting of a circuit board for full bandwidth signals. This probe head has the same tip pc board and the same length tip wires so it provides the same full bandwidth performance and fidelity as the solder-in probe head for measuring differential and single-ended signals. The tip wires for this probe head are tin plated spring steel that can be formed to different spacing and provide compliance for a reliable connection. The N5382A comes with an ergonomic handle to aid in positioning the probe head.

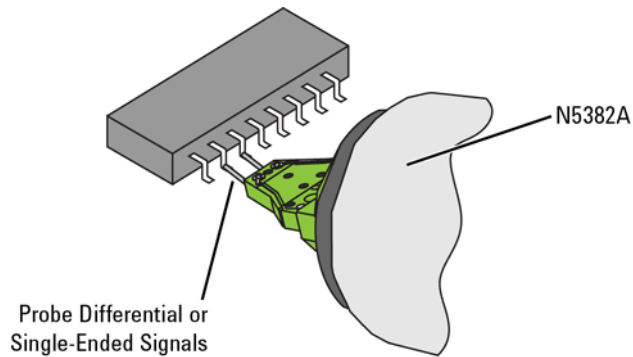

Figure 17 N5382A

Table 11 Supplied Accessories

Accessory	Quantity	Part Number
Ergonomic Handle	1	01130-43202
0.005 inch tin-plated steel wire		01169-21304
Trim Gauge	1	—

2 Using Probe Heads Recommended Configurations



TO INSTALL OR REPAIR THE LEADS. Refer to “N5381/2A Probe Heads” on page 104.

CAUTION

Figure 18 shows how to adjust the spacing of the browser’s wires without stressing the solder joint. Use tweezers to grab and stabilize the lead near the pc board edge. Then, without moving the tweezers, position the wires as needed. Stabilizing the wire near the solder joint reduces stress at the solder joint. The wires will last much longer with multiple adjustments. Although Figure 18 shows the N5381A probe head, the technique used is the same.

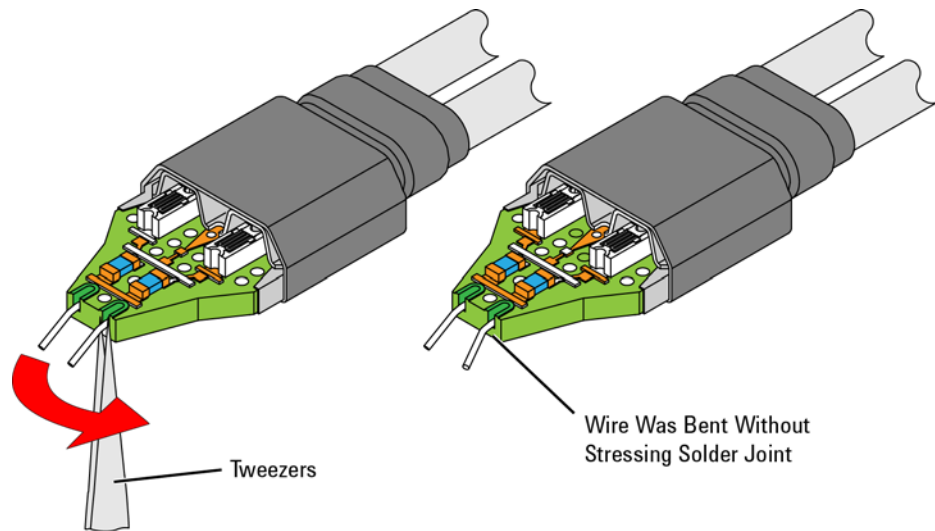

Figure 18 Adjusting Spacing Without Stressing Solder Joint

When holding the N5382A for extended periods of time, use the N5382A’s supplied ergonomic handle. Figure 19 on page 51 and Figure 20 show how to mount the browser in the ergonomic handle.

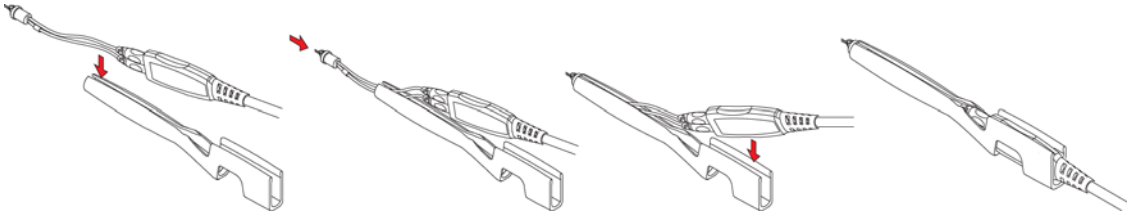

Figure 19 Inserting the Probe into the Handle

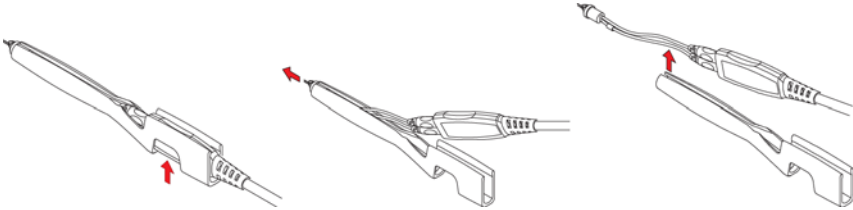

Figure 20 Removing the Probe from the Handle



PERFORMANCE PLOTS. Refer to “N5381A & N5382A Differential Probe Heads (Full BW)” on page 152.

3 N5380B SMA

Full BW
1168A:
>10 GHz
1169A:
>12 GHz



The N5380B SMA probe head provides the highest bandwidth for connecting to SMA connectors. The input resistance is 50Ω on both inputs. A shorting cap connects one side of both resistances to ground. For applications that require the resistances to be referenced to a voltage other than ground, the shorting cap can be removed and a dc voltage can be applied.

When disconnecting a probe amplifier from the N5380B SMA probe head, grasp the probe amplifier as shown in [Figure 21](#) and pull it straight away from the SMA probe head without any rocking (either side-to-side or up-and-down).

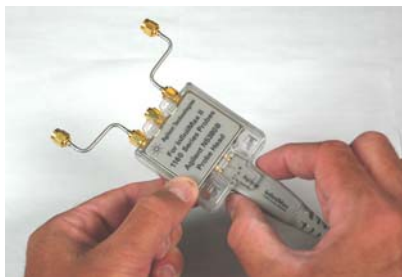

Figure 21 Disconnecting the N5380B

CAUTION

Pulling on the probe amplifier cable or strain relief, or rocking the probe amplifier to remove it, may damage the probe head or probe amplifier.

N5380A/B Head Support

The probe amplifier can become damaged if the N5380A/B does not have an N5380-64701 SMA head support attached. N5380B heads come with the SMA head support already attached. For older N5380A heads, the head support can be ordered. As shown in [Figure 22](#), the current design of the N5380-64701 has been changed from the original design. The original design is no longer offered. Both the original and new design provide the same level of protection for the probe amplifier and can be attached to both N5380B and N5380A heads.

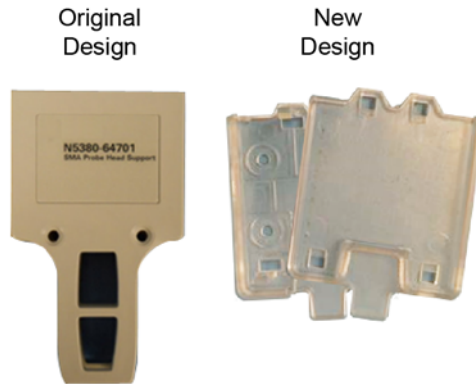

Figure 22 Original and New Head Support Designs



PERFORMANCE PLOTS. Refer to “N5380B SMA Probe Head (Full BW)” on page 148.

2 Using Probe Heads

Recommended Configurations

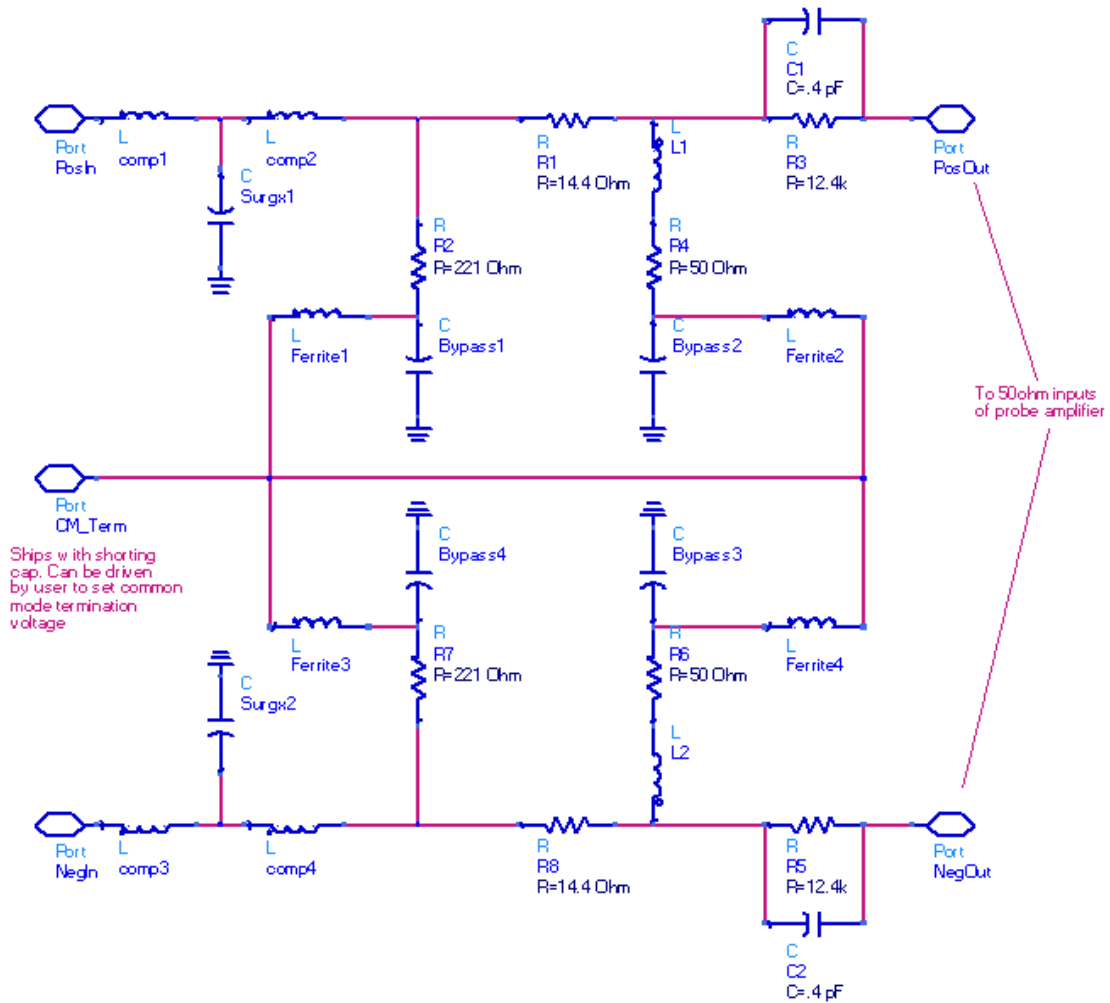

Figure 23 N5380B Schematic

4 N5425A with N5426A ZIF Tip

Full BW
1168A:
>10 GHz
1169A:
>12 GHz



The N5425A and N5426A combination provides the high bandwidth signals and the lowest capacitive loading for measuring both single-ended and differential signals. The N5426A ZIF tip accommodates very small fine pitch targets. For variable-pitch targets, use the N5451A tip as described in “N5425A with N5451A Long-Wire ZIF Tip (7 mm)” on page 60 and “N5425A with N5451A Long-Wire ZIF Tip (11 mm)” on page 62. The ZIF tip must be soldered to the circuit that you are measuring.

To attach the ZIF probe head into the ZIF tip, open (lift up) the tip’s black latch, insert the probe head into the tip, and close the latch. To solder a ZIF tip to your DUT, refer to “Soldering a ZIF Tip to a DUT” on page 78.

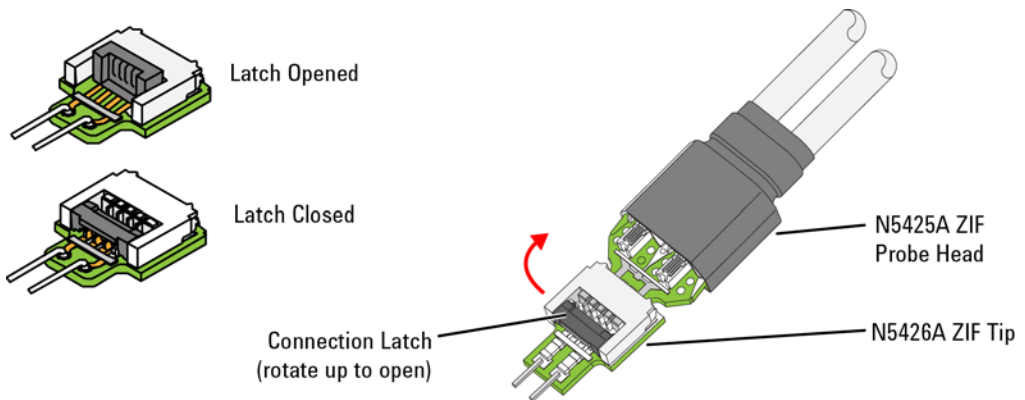

Figure 24 N5426A ZIF Head with N5451A ZIF Tip Attached

NOTE

The N5425A ZIF probe head does not come with any ZIF probe tips. ZIF probe tips N5426A, N5451A, or N2884A must be separately ordered.

2 Using Probe Heads

Recommended Configurations



PERFORMANCE PLOTS. Refer to “N5425A ZIF Probe Head (Full BW)” on page 157.



SPICE MODEL. Refer to “N5425A ZIF Head with N5426A ZIF Tip Attached” on page 220.

5 N5425A with N2884A Fine Wire ZIF Tip

Full BW
1168A:
>10 GHz
1169A:
>12 GHz

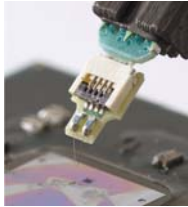

The N2884A fine-wired ZIF tip is similar to the N5426A and N5451A ZIF tips except they are equipped with 22 micron tungsten wires. As wires are extremely small and difficult to see, use a high-powered microscope when working with these tips. Please also note that it is important to handle these fine wire ZIF tips carefully as the thin wires can be easily damaged.

To attach the ZIF probe head into the ZIF tip, open (lift up) the tip's black latch, insert the probe head into the tip, and close the latch.

NOTE

To learn the proper method of using the N2884A tip, refer to "Using N2884A Fine-Wire ZIF tips" on page 83.

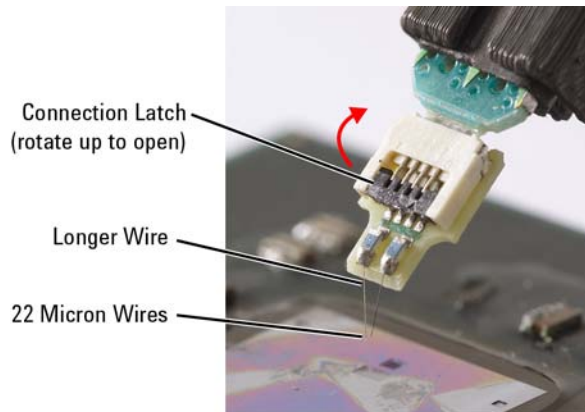

Figure 25 Fine Wires on N2884A Tip

2 Using Probe Heads

Recommended Configurations

NOTE

The N5425A ZIF probe head does not come with any ZIF probe tips. ZIF probe tips N5426A, N5451A, or N2884A must be separately ordered.



PERFORMANCE PLOTS. The response plots for the N2884A Fine Wire ZIF tips are substantially the same as the plots for the N5425A standard ZIF tip. Refer to “N5425A ZIF Probe Head (Full BW)” on page 157. The only major difference is that the bandwidth for the N2884A (with the 1169A probe amplifier) is slightly less than for the N5425A (12 GHz versus 12.3 GHz). Use the SPICE model for the N5425A to model the input loading for the N2884A.

The N2884A kit comes with five fine wire ZIF tips and one positioner arm with thumb nut (to mount the probe head to a micropositioner).

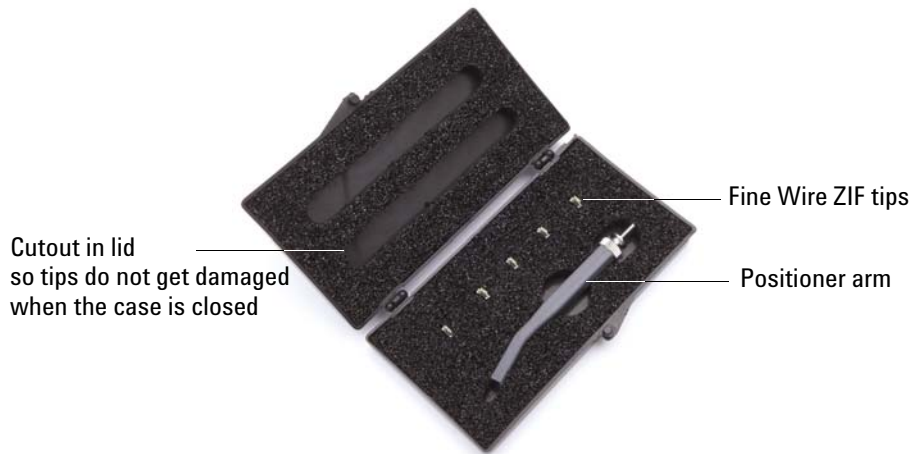

Figure 26 N2884A Kit with Fine Wire ZIF Tips

CAUTION

Be very careful with the 22 micron tungsten wires as they are very easily damaged.

CAUTION

It is very difficult to see the thin wires. Do not assume that they are not attached to the tip simply because you cannot see them at first glance.

CAUTION

When removing the tips from the packaging, use flat nose tweezers and grab the tip by the pc board. Do not ever grab the tip by the wires.

CAUTION

Once the tip is attached to the ZIF probe head, make sure the tip's latch is placed in the closed position to secure the connection.

CAUTION

Make sure the micropositioner is secured to something metallic (its base is magnetic) as it is nose-heavy. If it is left resting on a surface that the metallic base cannot secure to, it will tip over and the Fine Wire ZIF tip may become damaged.

CAUTION

When placing the Fine Wire ZIF tips back into the case, ensure that the tips are pointing directly up. The cutouts in the top of the case provide space for these wires when the case is closed. However, if the tips are not pointing directly up, they may miss these cutouts and become damaged.

CAUTION

When the Fine Wire ZIF tip is positioned under a microscope, be very careful with the lenses of the microscope as you adjust the magnification or focus. If one of the lenses strikes the tip, it could permanently damage it.

CAUTION

The two wires can come into contact during probing if you are not careful in preventing it. There are two ways this can happen. (1) If you set the longer wire and then try to probe a position with the short wire that forces their tips to cross, the two wires can touch. (2) When you set the wires, they will buckle. The wires may not be touching at their tips in this case (so they would look fine under a microscope), but the buckling could cause them to touch each other near their mid-points. Therefore, it is always a good idea to decrease the amount of magnification so you can see the entire wire lengths and make sure they are not in contact. Only turn on the device under test (DUT) when you have verified that the wires are not touching.

6 N5425A with N5451A Long-Wire ZIF Tip (7 mm)

0° Span
~9.9 GHz
BW
60° Span
~4.4 GHz



The N5451A long-wired ZIF tip with the resistor lengths trimmed to 7 mm accommodates variable-pitch targets. For very small fine pitch targets, use the N5426A tip as described in “N5425A with N5426A ZIF Tip” on page 55.

The tip must be soldered to the circuit you are measuring. This probe head’s leads use two 91Ω resistors. To attach the ZIF probe head into the ZIF tip, open (lift up) the tip’s black latch, insert the probe head into the tip, and close the latch.

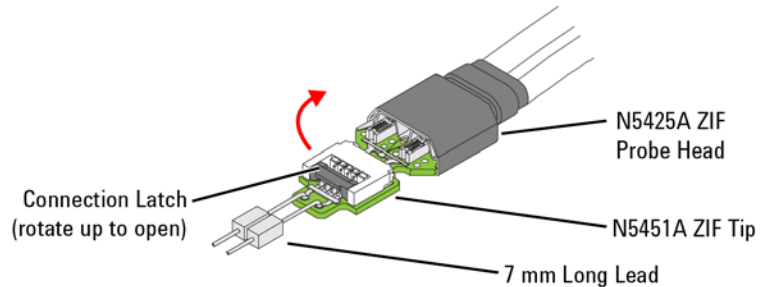
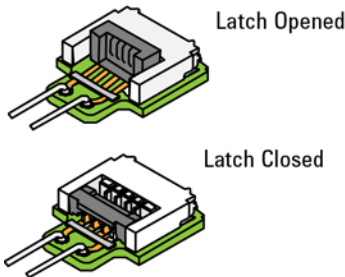

Figure 27 N5451A ZIF Tip Trimmed to 7 mm

NOTE

NOTE

The N5425A ZIF probe head does not come with any ZIF probe tips. ZIF probe tips N5426A, N5451A, or N2884A must be separately ordered.

To solder a ZIF tip to your DUT, refer to “Soldering a ZIF Tip to a DUT” on page 78.

Table 12 Supplied Accessories

Accessory	Quantity	Part Number
ZIF Tips	10	—
Long wire ZIF resistor lead	24	0700-1253
Trim Gauge	1	N5451A-94301



TO INSTALL OR REPAIR RESISTOR LEADS. Refer to “N5451A Long-Wired ZIF Tips” on page 109.



PERFORMANCE PLOTS. Refer to “N5425A ZIF Probe Head with N5451A Long-Wired ZIF Tip” on page 161.



SPICE MODEL. Refer to “N5425A ZIF Head with N5451A Long-Wire ZIF Tip” on page 226.

Removing ZIF Tips from the Packaging Strip

The N5451A long wire ZIF tip kit contains ten ZIF tips connected together in a strip. Before a ZIF tip can be used, it must be separated from its strip. To accomplish this, grab one of the tips with flat nose tweezers and bend it back. Then, bend the tip in the opposite direction and it should break off.

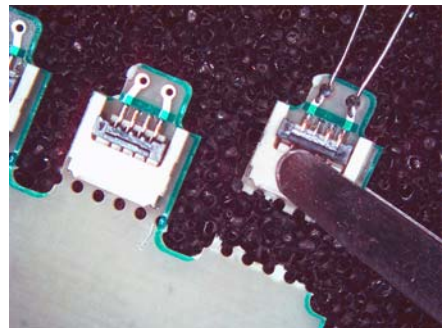

Figure 28 Breaking Off a Tip

7 N5425A with N5451A Long-Wire ZIF Tip (11 mm)

0° Span
~5 GHz
BW
60° Span
~3.3 GHz



Use the N5451A long-wired ZIF tip, with the resistor lengths trimmed to 11 mm, to accommodate variable-pitch targets. If a shorter resistor length can be used, you can increase the available bandwidth by using the 7 mm length described in “N5425A with N5451A Long-Wire ZIF Tip (7 mm)” on page 60. For very small fine pitch targets, use the N5426A tip as described in “N5425A with N5426A ZIF Tip” on page 55. To attach the ZIF probe head into the ZIF tip, open (lift up) the tip’s black latch, insert the probe head into the tip, and close the latch.

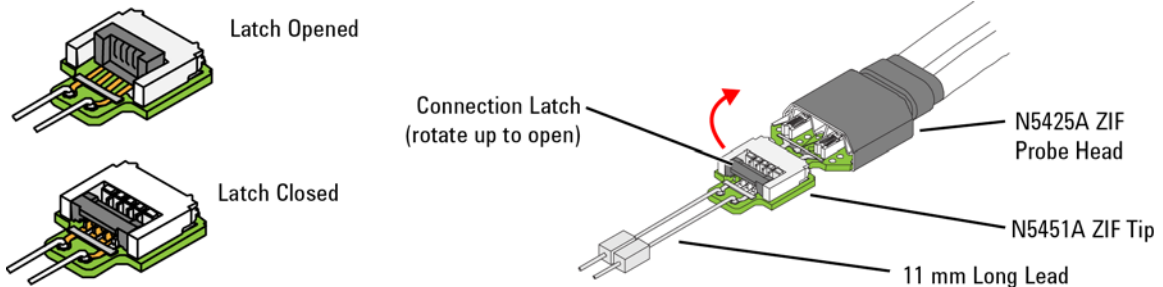

Figure 29 N5451A ZIF Tip Trimmed to 11 mm

NOTE

The N5425A ZIF probe head does not come with any ZIF probe tips. ZIF probe tips N5426A, N5451A, or N2884A must be separately ordered.

NOTE

To solder a ZIF tip to your DUT, refer to “Soldering a ZIF Tip to a DUT” on page 78.



TO INSTALL OR REPAIR RESISTOR LEADS. Refer to “N5451A Long-Wired ZIF Tips” on page 109.



PERFORMANCE PLOTS. Refer to “N5425A ZIF Probe Head with N5451A Long-Wired ZIF Tip” on page 161.



SPICE MODEL. Refer to “N5425A ZIF Head with N5451A Long-Wire ZIF Tip” on page 226.

Removing ZIF Tips from the Packaging Strip

The N5451A long wire ZIF tip kit contains ten ZIF tips connected together in a strip. Before a ZIF tip can be used, it must be separated from its strip. To accomplish this, grab one of the tips with flat nose tweezers and bend it back. Then, bend the tip in the opposite direction and it should break off.

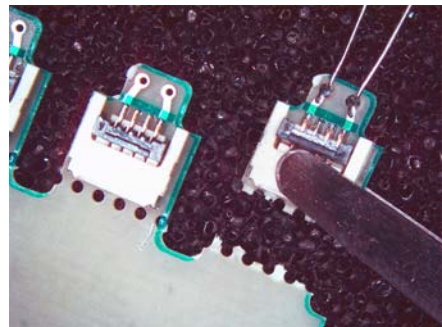

Figure 30 Breaking Off a Tip

8 E2677A Differential Solder-In Probe Head

Full BW
1168A:
>10 GHz
1169A:
>12 GHz



The E2677A probe configuration provides the full bandwidth signals and the lowest capacitive loading for measuring both single-ended and differential signals. This head allows a soldered connection into a system for a reliable, hands-free connection. At the tip it uses a miniature axial lead resistor with 8 mil diameter leads which allows connection to very small, fine pitch targets.

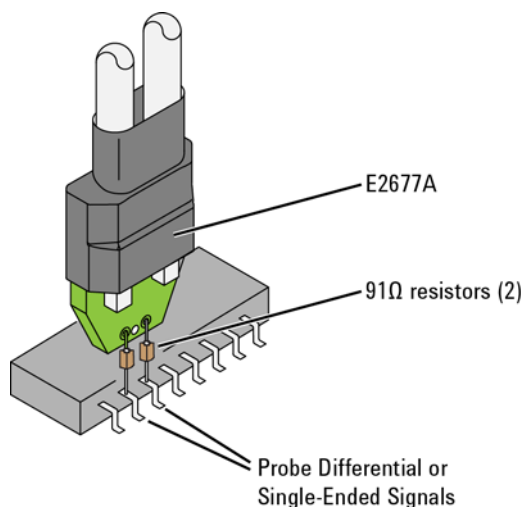

Figure 31 E2677A

The probe head resistors must be soldered to the circuit that you are measuring. Because of the small size of the resistor leads, it is easy to solder them to very small geometry circuits.



TO INSTALL OR REPAIR RESISTOR LEADS. Refer to “E2677A/9A Solder-In Probe Heads” on page 113.



PERFORMANCE PLOTS. Refer to “E2677A Differential Solder-in Probe Head (High BW)” on page 183.



SPICE MODEL. Refer to “E2677A Differential Solder-In Head” on page 244.

CAUTION

Do not solder in resistor leads with a big ball of solder right next to the resistor body. Normally the nickel lead will limit the heat transfer to the resistor body and protect the resistor, but if a ball of solder is right next to the resistor body on the lead, the resistor may come apart internally.

CAUTION

When soldering leads to DUT always use plenty of flux. The flux will ensure a good, strong solder joint without having to use an excessive amount of solder.

CAUTION

Strain relieve the micro coax leading away from the solder-in tips using hook-and-loop fasteners or adhesive tape to protect delicate connections.

NOTE

Cut resistors. Before using the resistors, the resistor wires must be cut to the correct dimensions. For the correct dimensions see “E2677A/9A Solder-In Probe Heads” on page 113

9 E2678A Differential Socketed Probe Head

Full BW
1168A:
>10 GHz
1169A:
>12 GHz



The E2678A probe configuration allows a removable, hands-free connection that provides full bandwidth with a minor increase in capacitance over the probe head for probing differential and single-ended signals.

The 82Ω axial lead resistors are soldered to the circuit that you are measuring. The socketed differential probe head is plugged onto the resistors. This makes it easier to move the probe from one location to another. Because of the larger size of the resistor leads, the target for soldering must be larger than the solder-in probe heads.

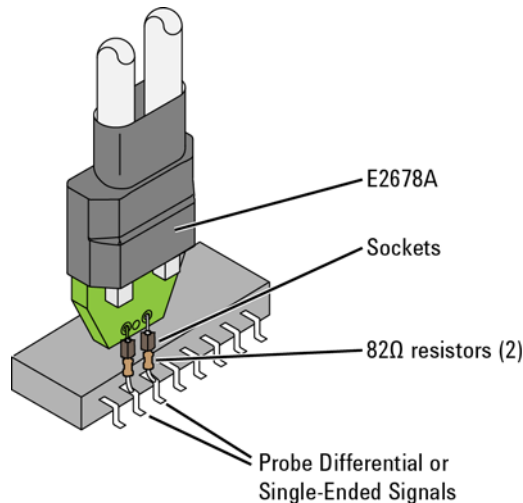

Figure 32 E2678A



TO INSTALL OR REPAIR RESISTOR LEADS. Refer to the information found in this section.



PERFORMANCE PLOTS. Refer to “E2678A Differential Socketed Probe Head (High BW)” on page 186.



SPICE MODEL. Refer to “E2678A Differential Socket Tip Head” on page 242.

PC Board Target Dimensions

The spacing for the socketed tip differential probe head is 0.100 inch (2.54 mm). For soldering on a PC board, the targets can be two vias that can accept the 0.020 inch (0.508 mm) diameter resistor leads. A via of 0.025 inch (0.0635 mm) diameter is recommended. If soldering a resistor lead to a surface pad on your PC board, the resistor leads can be bent in an "L" shape and soldered down. A pad size of at least 0.030 x 0.030 inch (0.762 mm x 0.762 mm) is recommended.

Shaping the Resistors

Before installing the 82Ω resistors (01130-81506) onto your device under test, the resistor wires must be trimmed using diagonal cutters and bent to the correct dimensions as shown in Figure 33. Use tweezers, to place the resistor body inside the rectangle of the supplied trim gauge. Use diagonal cutters to trim the leads even with the trim lines.

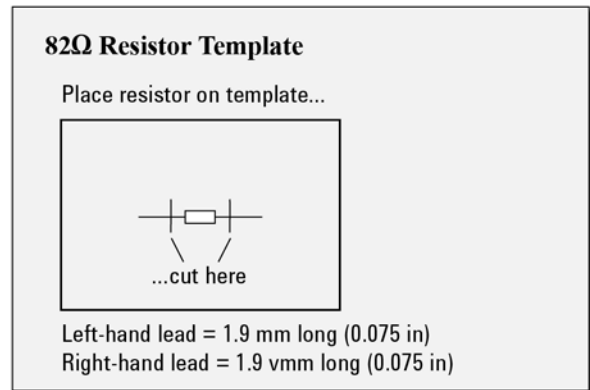
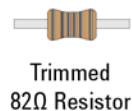

Figure 33 Resistor Trim Dimensions and Trim Gauge

10 E2675A Differential Browser

BW
~5.2 GHz



The E2675A differential browser configuration is the best choice for general purpose troubleshooting of a circuit board. The tab on the side of the probe allows the probe tips to be adjusted for different circuit geometries. The E2675A comes with an optional ergonomic handle to aid in positioning the probe head.

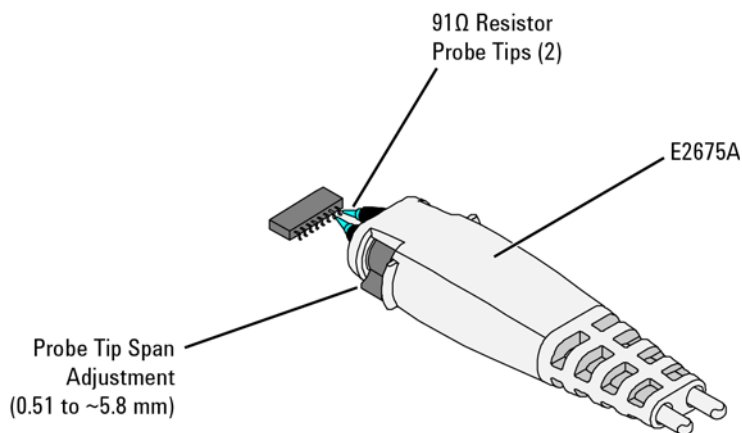

Figure 34 Differential Browser

Do not use the E2675A probe head as a tool to scrape solder mask or other items off of a circuit board. The blue tips can easily be broken off if the browser is not used properly. Always hold the probe head so that the blue tips remain vertical during measurements as shown in [Figure 35](#).



Figure 35 Proper Vertical Orientation of the Blue Tips



PERFORMANCE PLOTS. Refer to “E2675A Differential Browser” on page 177.



SPICE MODEL. Refer to “E2675A Differential Browser Probe Head” on page 241.

When holding the E2675A for extended periods of time, use the supplied ergonomic handle. [Figure 36](#) and [Figure 37](#) show how to attach and remove the handle from the probe head.

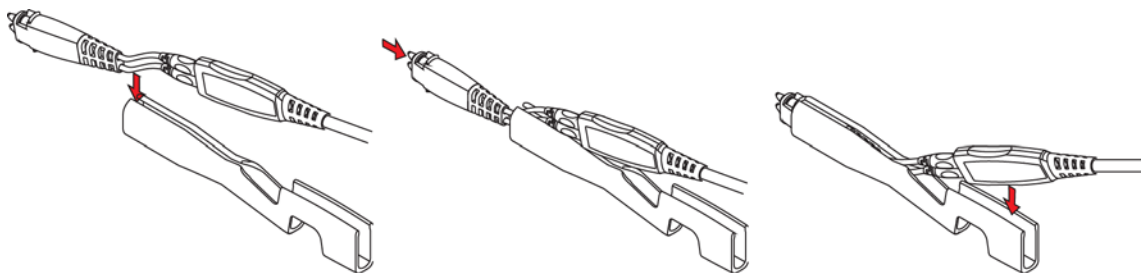

Figure 36 Inserting the Probe

2 Using Probe Heads
Recommended Configurations

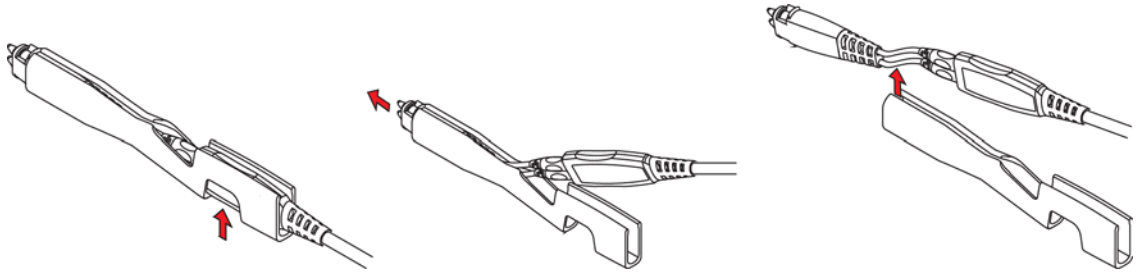

Figure 37 Removing the Probe

11 E2679A Single-Ended Solder-in Probe Head

BW
~5.2 GHz



The E2679A probe configuration provides good bandwidth measurements of single-ended signals only with a probe head that is physically very small. The probe head resistors must be soldered to the circuit that you are measuring. Because of the small size of the resistor leads, it is easy to solder them to very small geometry circuits.

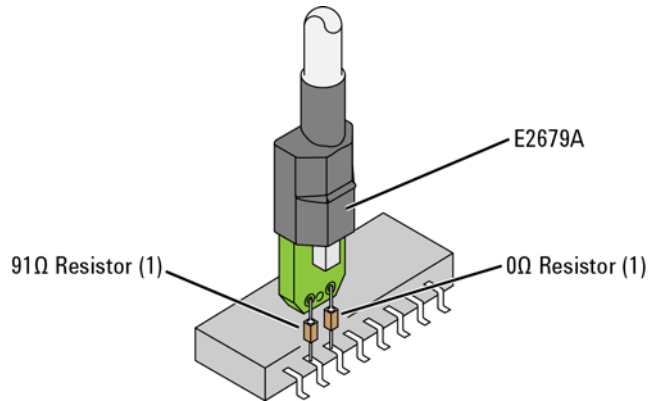

Figure 38 E2679A

This probe head's leads use a 91Ω and 0Ω mini-axial lead resistors.



TO INSTALL OR REPAIR RESISTOR LEADS. Refer to “E2677A/9A Solder-In Probe Heads” on page 113.



PERFORMANCE PLOTS. Refer to “E2679A Single-Ended Solder-In Probe Head (High BW)” on page 192.



SPICE MODEL. Refer to “E2679A Single-Ended Solder-In Head” on page 246.

2 Using Probe Heads

Recommended Configurations

CAUTION

Do not solder in resistor leads with a big ball of solder right next to the resistor body. Normally the nickel lead will limit the heat transfer to the resistor body and protect the resistor, but if a ball of solder is right next to the resistor body on the lead, the resistor may come apart internally.

CAUTION

When soldering leads to DUT always use plenty of flux. The flux will ensure a good, strong solder joint without having to use an excessive amount of solder.

CAUTION

Strain relieve the micro coax leading away from the solder-in tips using hook-and-loop fasteners or adhesive tape to protect delicate connections.

12 E2676A Single-Ended Browser

BW
~6 GHz



The E2676A single-ended browser is a good general purpose probing of single-ended signals when physical size is critical. Excessive peaking (+6 dB) can occur at about 9 GHz. Therefore, limit the bandwidth of the input signal.

For wider spans with non-performance critical browsing (rise times greater than approximately 0.5 ns), the 5063-2120 socketed ground lead can be used in place of the 01130-60005 ground collar.

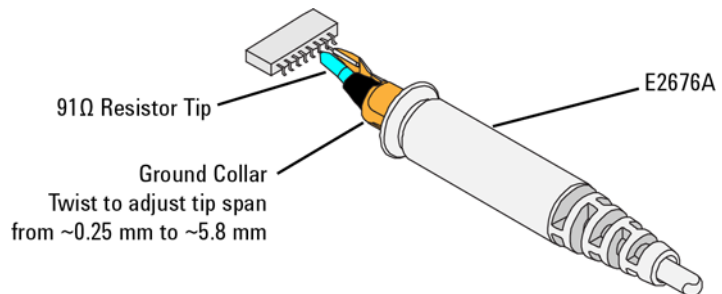

Figure 39 E2676A



PERFORMANCE PLOTS. Refer to “E2676A Single-Ended Browser” on page 180.



SPICE MODEL. Refer to “E2676A Single-Ended Browser Head” on page 245.

When holding the E2675A for extended periods of time, use the supplied ergonomic handle. Figure 40 and Figure 41 show how to attach and remove the handle from the probe head.

2 Using Probe Heads
Recommended Configurations

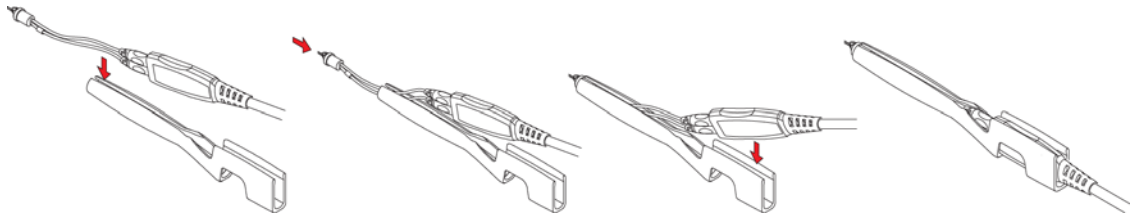

Figure 40 Inserting the Probe into the Handle

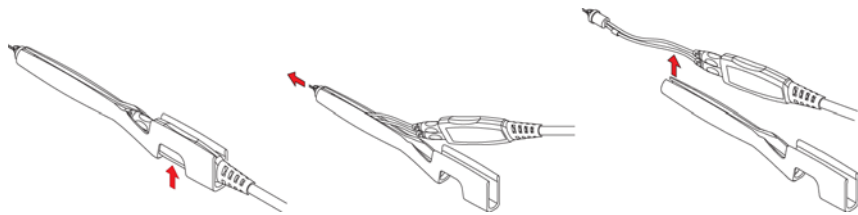

Figure 41 Removing the Probe from the Handle

13 E2678A Differential Socketed & Damped Wire Accessory

BW
~1.2 GHz



This E2678A probe configuration provides maximum connection reach and flexibility with good signal fidelity but lower bandwidth for measuring differential or single-ended signals. The damped wires must be soldered to the circuit that you are measuring. This configuration can probe circuit points that are farther apart than other configurations. This probe head come with a damped wire accessory that includes two 160Ω resistors.

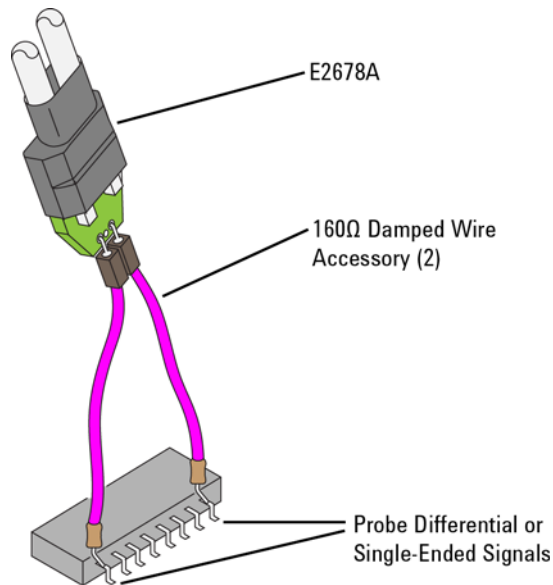

Figure 42 E2678A with Damped Wire Accessory

2 Using Probe Heads

Recommended Configurations

This probe configuration can be used to connect to 25 mil square pin headers with 100 mil spacing such as those used in USB testing. If the header adapter is used with the 1168A (10 GHz) or the 1169A (12 GHz), the rise time of the input signal should be slower than ~ 150 ps (10% to 90%) to limit the effects of resonances in the adapter.

All of the specifications and characteristics of the header adapter are the same as those for the socketed differential probe head except for the input capacitance shown in Table 13.



PERFORMANCE PLOTS. Refer to “E2678A Differential Socketed Probe Head (High BW)” on page 186.

Adapting the Damped Wire Accessory from Solder-In to Plug-On

To adapt the damped wire accessory (01130-21302), solder the tip into the 01131-85201 square pin socket and then slip the 01131-41101 heat-shrink sleeve over the solder joint and heat the heat-shrink tubing with a heat gun.

Table 13 Characteristic Capacitance

Identification	Capacitance	Description
C_m	0.43 pF	Model for input C is C _m between the tips and C _g to ground each tip
C_g	0.54 pF	
C_{diff}	0.70 pF	Differential mode capacitance is C _m + C _g /2
C_{se}	0.97 pF	Single-ended mode capacitance is C _m + C _g

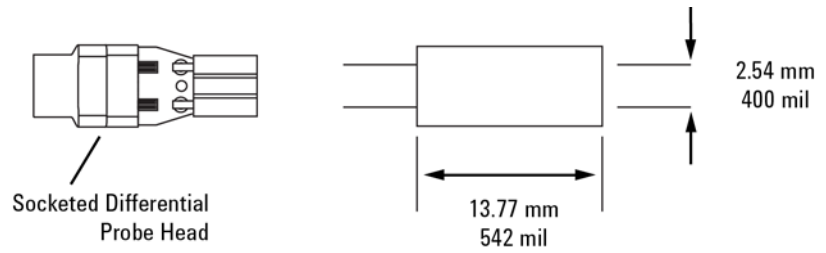

Figure 43 01130-63201 Header Adapter Dimensions

Soldering a ZIF Tip to a DUT

Overview Soldering a ZIF tip into a DUT is straightforward, but some of the traditional soldering techniques that are typically used on larger components will not work well here. The following is an overview of the recommended soldering techniques

- 1 Add some solder to the DUT connection points. There should be enough solder to provide a good fillet around the ZIF tip's leads, but not so much as to create a big solder ball. A fine MetCal (or equivalent) soldering tip should be used along with some 11 or 15 mil solder.
- 2 Using a rosin flux pen, coat the solder points with flux. The flux core solder does not provide enough flux for this small scale soldering. Also, put flux on the tips of the leads of the ZIF tip.
- 3 Clean the soldering tip well, then add a little bit of solder to the tip. It may take several tries to get just a little bit of solder right at or near the tip of the soldering iron. The solder on the tip keeps the soldering iron tip from pulling solder off the DUT connection points. This step may be optional if there is already enough solder on the DUT connection points.
- 4 Position a lead of the ZIF tip on top of one of the target points, then briefly touch the soldering iron tip to the joint. The thermal mass of this joint is very small, so you don't need to dwell on the joint for very long. The flux that was added to the joint should produce a good, clean solder joint. If you do not get a good, shiny, strong solder joint, then there was either not enough flux or the joint was heated too long and the flux boiled off.
- 5 There is a possibility that if a lead of the ZIF tip is inserted into a large ball of solder that is heated excessively with a soldering iron, the solder joint holding the lead onto the ZIF tip pc board could flow and the lead would come off destroying the ZIF tip. Only the first third of the lead or so needs to be soldered to the target point.

Detailed Procedure

This is an example of installing a ZIF tip to an IC package. The ZIF tip is attached to the first two package leads. The target could also be via pads or signal traces.

- 1 Add some solder to the target points in the DUT. Figure 44 shows extra solder added to the pads for the first two pins on an IC package.

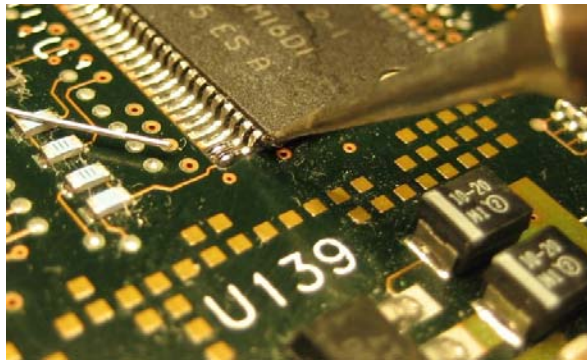

Figure 44 Solder Added to Target Points

- 2 Use flux pen to add flux to the target points. Also, flux the tip of the lead on the ZIF tip at this time.



Figure 45 Fluxing of the Target Points

2 Using Probe Heads

Soldering a ZIF Tip to a DUT

- 3 Clean the soldering iron tip and add a small amount of solder to the very tip. This may take a few tries because the solder may tend to ball up and move away from the tip.



Figure 46 Small Amount of Solder Added to Soldering Iron Tip

- 4 Connect the ZIF tip to the ZIF probe head. This allows the probe head to be used as a handle for the ZIF tip to allow positioning in the DUT. Position the lead wires on the target points and then briefly heat the solder joints. There should be enough solder to form a good fillet and enough flux to make the joint shiny. There shouldn't be so much solder that the big solder ball is formed that could cause a solder bridge or overheat the leads on the ZIF tip.

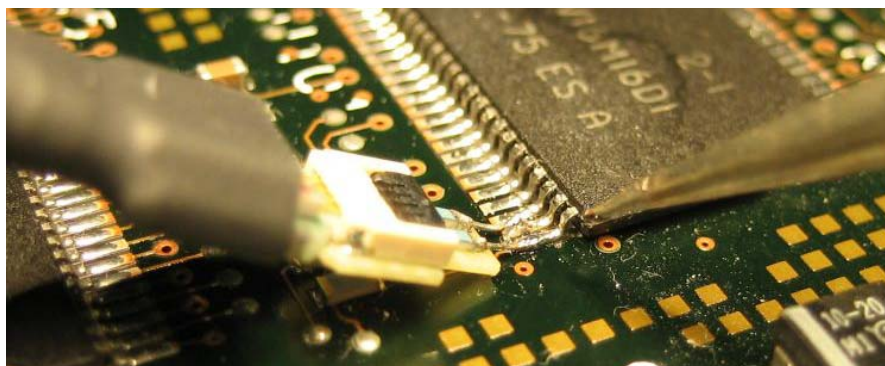

Figure 47 ZIF tip Positioned and Soldered In Place

- 5 Open the ZIF tip latch, and remove ZIF probe head and leave ZIF tip behind for future connection. It is best to use a non-conductive, pointed object such as a toothpick or plastic

tool. Hold on the heat-shrink part of the probe head to support the ZIF tip while releasing the latch.

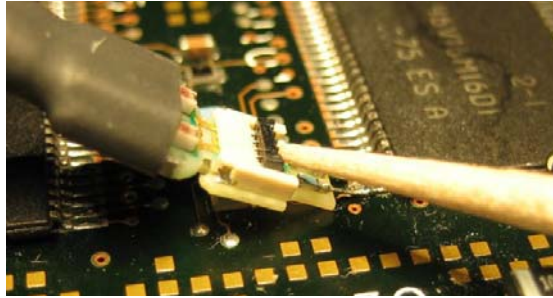

Figure 48 Using a Non-Conductive Tool to Open the ZIF Tip's Latch

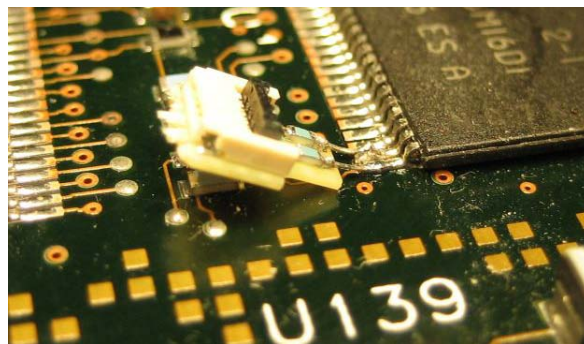

Figure 49 ZIF Tip with ZIF Latch Open

- 6 To make a measurement, connect a ZIF probe head to the ZIF tip. Open the tip's latch, insert the probe head into the ZIF socket, and close the tip's latch with a non-conductive tool. See [Figure 50](#).

NOTE

You may need to support the body of the ZIF tip while closing the latch. Use tweezers or other suitable tool to grab the tip's pc board while the latch is being closed. If the circuit is live, use plastic or non-conductive tweezers.

2 Using Probe Heads
Soldering a ZIF Tip to a DUT

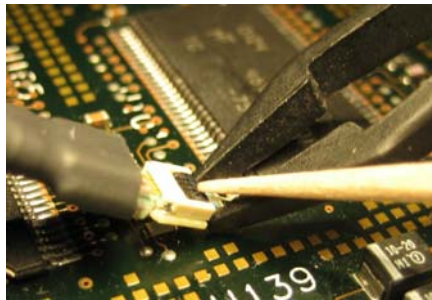

Figure 50 Use a Non-conductive Tool to Close the Latch

Using N2884A Fine-Wire ZIF tips

The procedure required to use these tips is very specific. Please read the instructions carefully as each step alerts you to common problem areas and things you need to be aware of when using this tip.

Step 1. Calibrate the Probe

If you have not recently calibrated the probe or if this is the first time you have ever used this probe amplifier/head/tip combination on the specific oscilloscope channel you plan on using, you should calibrate the probe. The best and easiest way to calibrate this probe setup is to use the standard N5425A ZIF tips rather than the fine wire ZIF tips (since they are very similar in their electrical response characteristics and it is much easier to quickly work with the standard N5425A ZIF tip).

Step 2. Place the ZIF Probe Head (N5425A) into the Positioner Arm

Insert the N5425A ZIF probe head into the positioner arm as shown in [Figure 51](#) on page 84. The fine wire ZIF tip should not be connected to the N5425A ZIF probe head yet.

NOTE

The positioner arm is located inside the case with the five fine wire ZIF tips.

2 Using Probe Heads

Using N2884A Fine-Wire ZIF tips

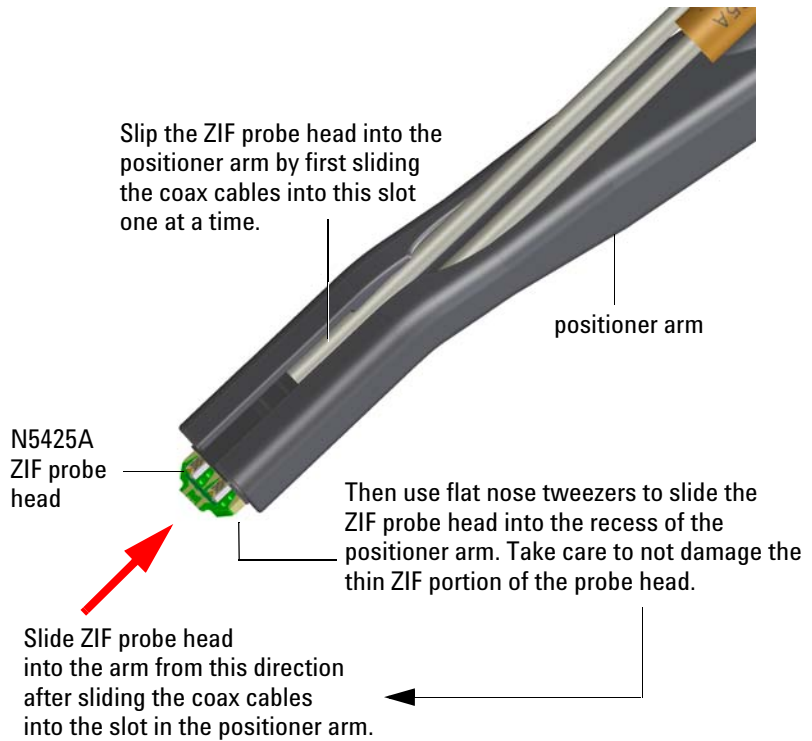

Figure 51 Probe Head and Tip in Positioner

Step 3. Install the Positioner Arm Into the Micropositioner

Secure the positioner arm to a micropositioner using the thumb nut as shown in [Figure 52](#) on page 85. Agilent recommends using the Wentworth Laboratories micropositioner shown in the picture. You can either order it directly from Wentworth Laboratories (www.wentworthlabs.com) or you can order it from Agilent. If you order it through Agilent, you must order *both* of the following two parts:

- N2884-64702 (Wentworth 2026-90409 PVX 400-M: Manual Linear Manipulator Magnetic Base)

- N2884-64703 (Wentworth 5-00-4711 Short Nose Articulated Short Arm Front)

NOTE

While Agilent recommends using the Wentworth micropositioner, the Fine Wire ZIF positioner arm is compatible with many micropositioners as long as the thumb nut has enough threads to firmly secure the positioner arm.

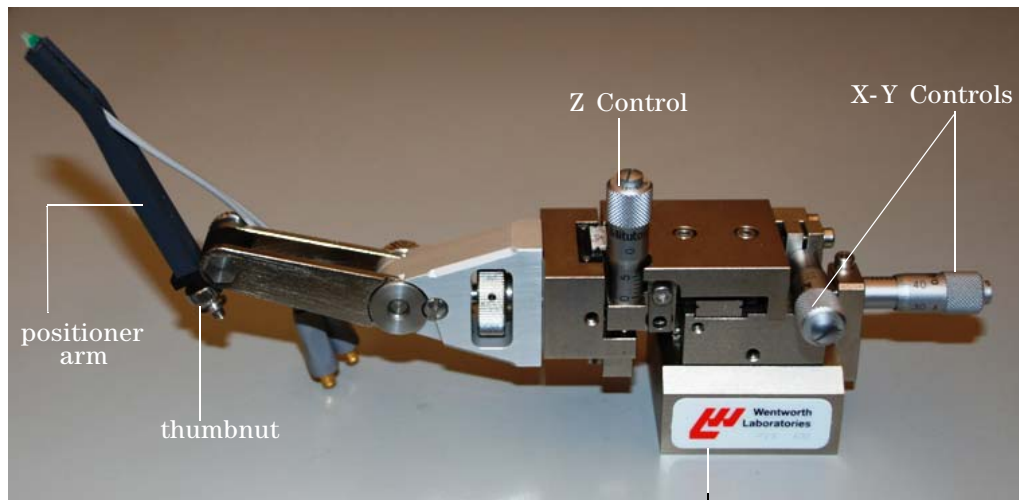

Figure 52 Micropositioner

Step 4. Secure the Micropositioner

When the Fine Wire ZIF tips are attached to the probe head, it is important that the micropositioner is properly secured. It is nose-heavy so if the surface it is on does not allow its magnetic base to secure it, the micropositioner will tip over and damage the ZIF tip. Therefore, you need to place the micropositioner on a metallic surface and ensure that its metallic base is indeed secured so it will not tip over.

Step 5. Attach the Probe Head to Probe Amplifier

Once the Fine Wire ZIF tip is attached to the probe head, it will be extremely important that you are careful with the entire setup (so you do not crush or damage the wires). Therefore, it is usually easiest to connect the probe head to

2 Using Probe Heads

Using N2884A Fine-Wire ZIF tips

the InfiniiMax probe amplifier before you attach the Fine Wire ZIF tips. You can also connect the probe amplifier to the oscilloscope at this time.

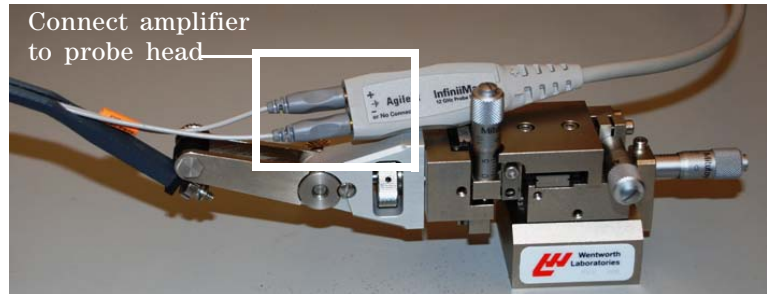

Figure 53 Amplifier Connected to Probe Head

Step 6. Remove a Fine Wire ZIF tip From the Case

To remove a tip from the packaging, grasp the pc board of the tip with flat nose tweezers and lift directly out of the foam. See [Figure 54](#) on page 87.

CAUTION

Do not ever lift the tip out by grasping the wires.

CAUTION

In the case, each of the five Fine Wire ZIF tips has its wires pointing directly up. There is a cutout in the case's lid that allows for these wires to not be bent when the lid is closed. If the wires are not pointed directly upward, they could become damaged when the lid is closed.

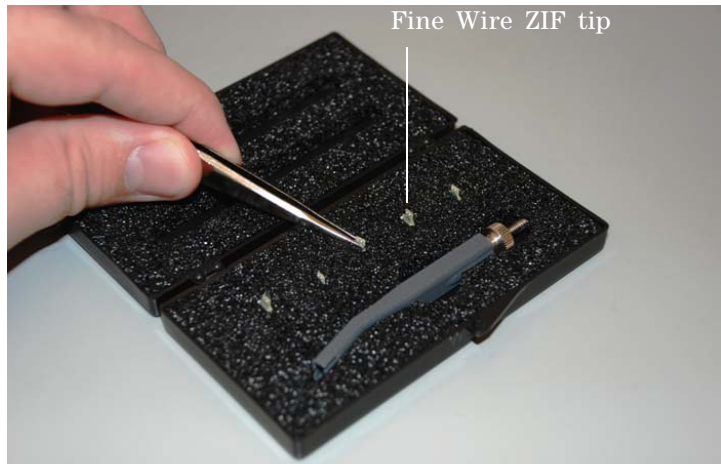

Figure 54 Removing the ZIF Tip

Step 7. Attach the ZIF Probe Head to the Fine Wire ZIF tip

While still grasping the tip with flat nose tweezers, use another set of tweezers to lift the latch to the open position as shown in Figure 55 on page 87). Be careful to not hit the wires. The picture shows the standard ZIF tip and is only meant to highlight the latch's open position (the latch is the same on the standard and Fine Wire ZIF tips).

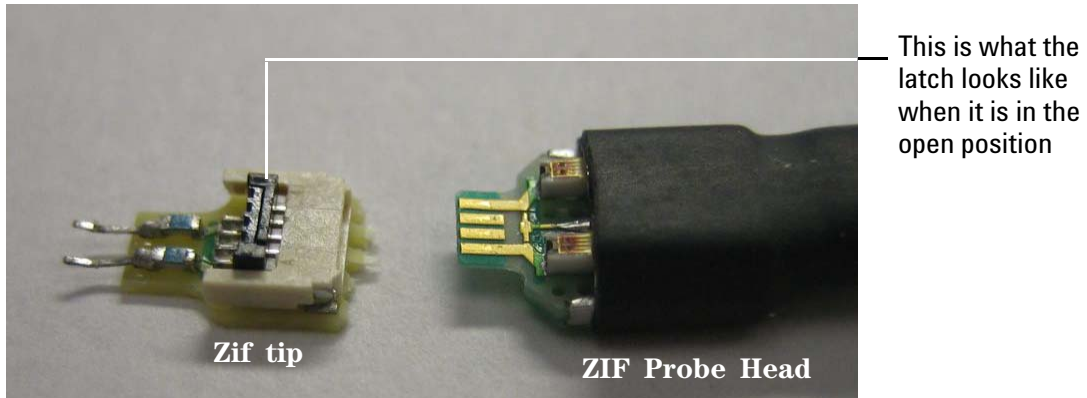

Figure 55 ZIF Tip Latch in Open Position

2 Using Probe Heads

Using N2884A Fine-Wire ZIF tips

The probe head should already be attached to the positioner arm (which is secured to the micropositioner). Push the Fine Wire ZIF tip onto the probe head and close the latch to lock them together. The picture below does not show the probe head inside the positioner arm. It is meant to show you what the latch looks like when it is closed.

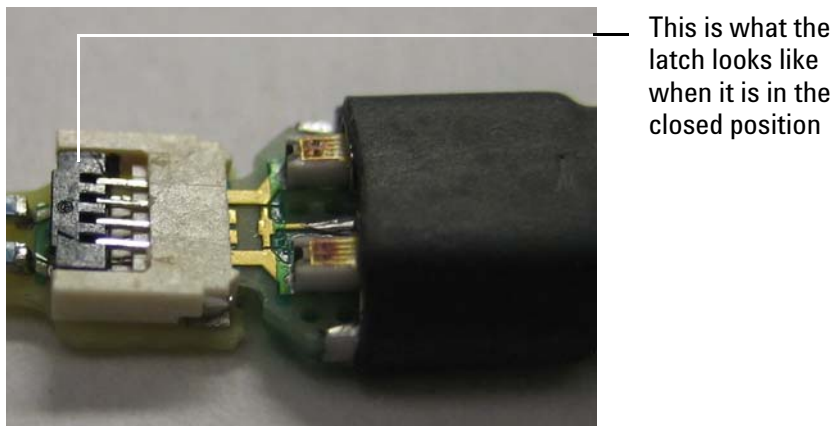

Figure 56 ZIF Tip Latch in Closed Position

Step 8. Attach the Fine Wire ZIF tip Onto the Board

The procedure described below is for probing the underside of ICs and describes a specific use-scenario. There may be other possible ways to use this probe tip. The following steps require a probing station and a high-powered microscope.

NOTE

Do not turn on your DUT until you have landed both wires and confirmed they are not touching, as described below.

In order to prepare the IC for probing, you first need to chemically etch a large trench out of the IC. Within the trench, create at least two wells (target well and ground well) to the targeted metal layers. These wells should be approximately 15 x 15 microns and 10 microns deep. These wells keep the probe tip from slipping across the surface as they give a place for the wires to anchor. You may need to create many wells depending on the number of targets you

want to probe, but you at least need two in order to have a ground well and a target well. A small amount of tungsten should be placed in the bottom of each well. The maximum distance between wells is 600 microns.

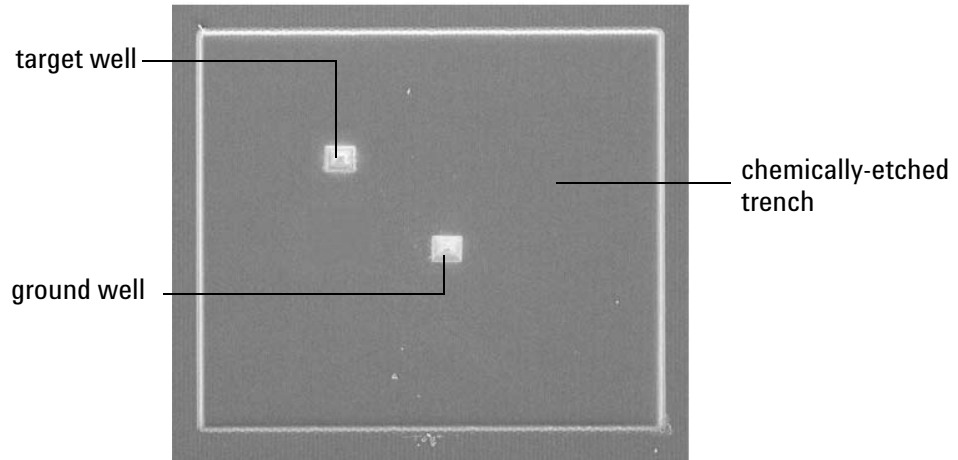

Figure 57 Example of Trench and Two Wells Under Magnification

The two 22 micron wires on the Fine Wire ZIF tip are of different lengths. The longer wire will be driven down first to set the z-axis and then you will land the short wire. It does not matter which wire goes into the ground well and which goes into the target well, but it does matter that the longer wire is set first.

2 Using Probe Heads

Using N2884A Fine-Wire ZIF tips

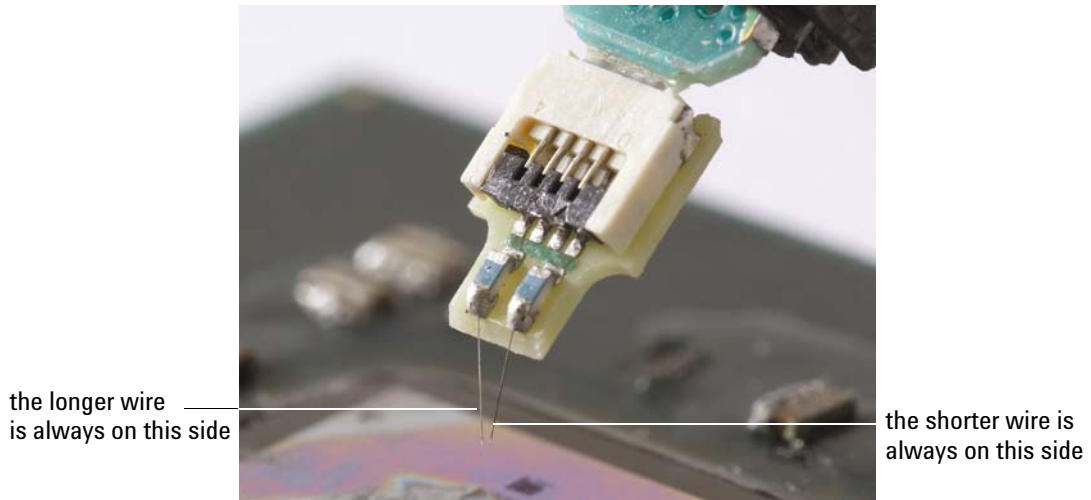
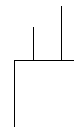
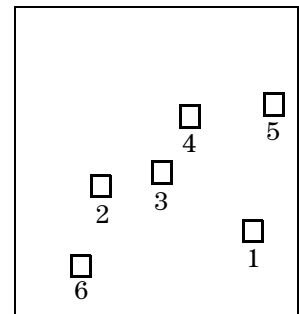

Figure 58 ZIF Tip Wires

It also matters how the two wells are positioned relative to each other. When you land the longer wire first, you will want to land it in a well that is below and to the right (from the perspective of the probing direction) relative to the wells in which you are going to land the short wire. In the diagram above, you could land the longer wire in well 1 and then probe locations 2, 3, and 4 with the short wire. You could not, however, reach well 5 with the short wire (the two wires could cross, shorting them in the process). You also could not reach well 6 with the short wire due to the configurations of the wire (this will cause an upward bend in the wires that could be detrimental to



Fine Wire ZIF tip

the probing performance). The short wire wells will always need to be up and to the left of the long wire well (from the perspective of the probing direction).

To land both of the wires in the wells, first position the IC under a microscope and move both wires into the region as shown below.

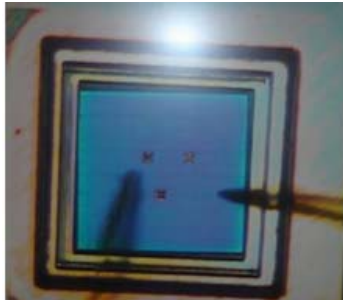

The two pointed shadows shown in the image to the left are the 22 micron wires

Figure 59 Wires in Wells

How easy the rest of these steps are will depend on how powerful of a microscope you have. It may take a while to get adjusted to the process, but with some practice, you should grow in your comfort level.

Move the positioner in the x-y direction until the tip of the long wire is above its well. You may not be able to see the wells and the wires in focus at the same time. If this is the case then first focus on the wells and then slowly move the focus out until you can see just the tips of the wires. You should then be able to move the longer wire tip over the first well.

Next, slowly land the tip in its well (using the z-direction adjustment on the micropositioner). Keep moving down until you see the end of the wire bend slightly. This will ensure that this wire remains stuck while we translate the shorter wire in the next step. Do not land the longer wire too hard or you could damage it. Once you see it flex, stop moving in the z-direction and use the x-y knobs on the micropositioner

2 Using Probe Heads

Using N2884A Fine-Wire ZIF tips

to wiggle the longer wire slightly. If the wire wiggles, but stays stuck in place on the IC then it was properly placed in the well.



Land the longer of the two wires in its well

Figure 60 Longer Wire Landed

With the longer wire in place, move the micropositioner in the x-y direction until the shorter wire is over the target well. Then adjust the positioner in the z-direction to land the shorter wire into its well.



Land the shorter of wires into its well

Figure 61 Shorter Wire Landed

The Fine Wire ZIF tip should now be ready to make a differential measurement. Before turning on your DUT, you need to ensure that the two wires are not touching. You should be able to confirm in the microscope that the tips are not overlapping, but these wires do buckle when you land them so they could be touching further up the wires. Decrease the magnification of the microscope until you can see the entire length of both wires and ensure that the wires are not touching.

**Step 9. Configuring the
Correct Settings on Your
Oscilloscope**

You should select the N5425A probe head in the probe menu on your oscilloscope when using the Fine Wire ZIF tip. You are now ready to acquire a signal.

N2887A/8A Soft Touch Probe Heads



N2887A



N2888A

The N2887A pro series and N2888A half-channel Soft Touch probe heads for logic analyzers eliminate the connector that is traditionally attached to the target board and replaces it with an array of probe pods. The probe heads adapt from the Agilent Pro-Series Soft-touch foot print to the GPO input connectors found on the 1168A/9A and 1130/1/2/4A series probe amplifiers.

Each probe head supports both single-ended and differential footprints and pin-outs. You can connect either a single-ended channel (one connector) into the positive (+) input of the probe amplifier or by plugging the differential complements (2 connectors) into the appropriate positive (+) and negative (-) inputs of the probe amplifier. There exists a 1:1 mapping of Soft touch signal and clock lanes to probe amplifier input GPO connectors. A total of 36 or 18 GPO connectors is necessary to support the possible configurations probe heads.



Figure 62 Soft Touch Head Connected to Probe Amplifier



PERFORMANCE PLOTS. Refer to “N2887A/N2888A Soft Touch Probe Heads” on page 194.

Retention Modules

You attach the probe heads to the PC board using a retention module, which ensures pin-to-pad alignment and holds the probe in place. A kit of five retention modules is shipped with each probe head. Additional kits can be ordered.

Table 14 Accessories / Replacement Parts

Part Number	Description
E5405-68702	Retention Module Replacement kit for N2887A
E5396-68702	Retention Module Replacement kit for N2888A
N2887-60002	De-skew and Performance Verification Fixture

The Agilent specific probe head retention modules do not match any other vendor's connectors. The footprint of the probe heads *do* match other vendors, but the retention modules do not match.

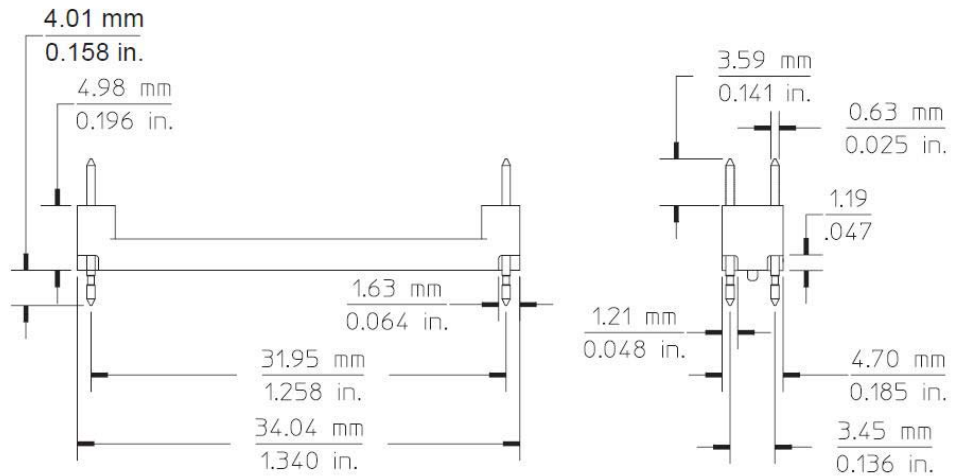

Figure 63 N2887A Retention Module Dimensions

2 Using Probe Heads
N2887A/8A Soft Touch Probe Heads

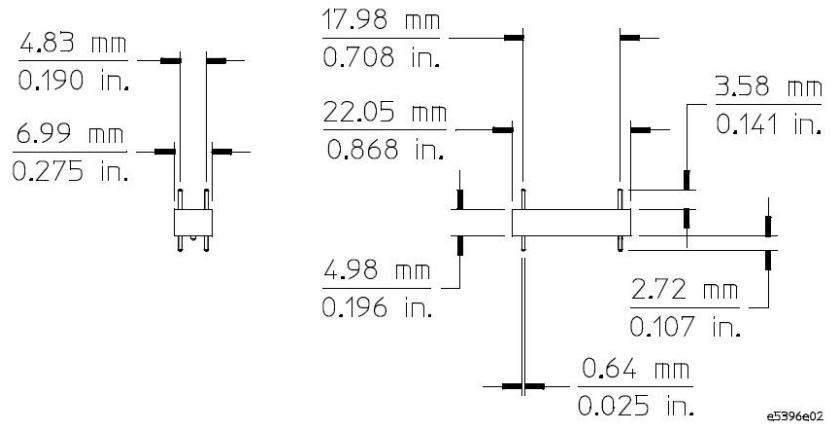

Figure 64 N2888A Retention Module Dimensions

Characteristics

The probe and oscilloscope combination should be warmed up for at least 20 minutes before any testing and the environmental conditions should not exceed the probe's specified limits.

Table 15 N2887A / N2888A Characteristics (Typical)

Item	Characteristic
Bandwidth (-3 dB)	4 GHz
Flatness	± 5%
Single-ended Equivalent Loading Capacitance	< 1 pF
Differential Equivalent Loading Capacitance	< 0.5 pF
Single-ended Input Impedance	25 kΩ
Differential Input Impedance	50 kΩ
Channel to Channel Coupling	< -35 dB to 1.7 GHz, < -20 dB to 4 GHz
Channel to Channel Skew	< 15 ps

N2887A Footprint Dimensions

The view in [Figure 65](#) is looking down onto the footprint on the printed circuit board. The numbers of the following paragraphs are labeled in the diagram:

- ❶ Must maintain a solder mask web between pads when traces are routed between the pads on the same layer. Solder mask may not encroach onto the pads within the pad dimension shown.
- ❷ Via in pad not allowed on these pads. Via edges may be tangent to pad edges as long as solder mask web between vias and pads is maintained.
- ❸ Permissible surface finishes on pad are HASL, immersion silver, or gold over nickel.
- ❹ Footprint is compatible with retention model E5405-68702.
- ❺ Plated through hole should not be tied to ground plane for thermal relief.

2 Using Probe Heads
N2887A/8A Soft Touch Probe Heads

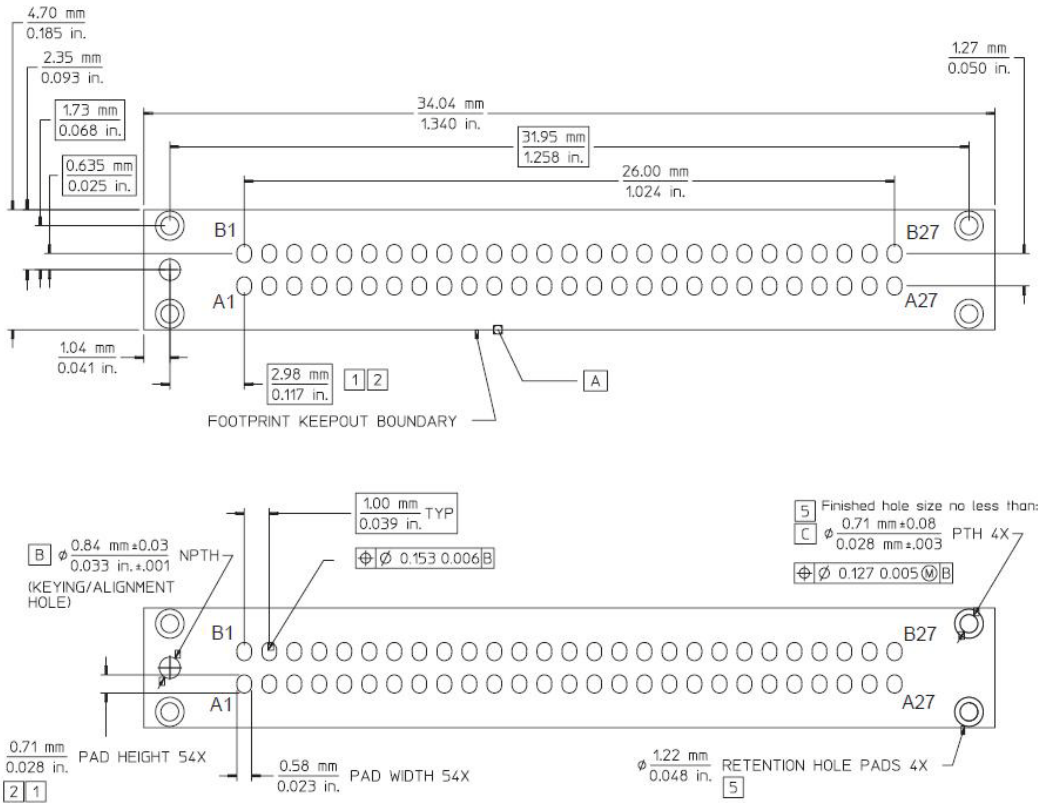

Figure 65 N2887A Footprint Dimensions

N2888A Footprint Dimensions

The view in [Figure 66](#) is looking down onto the footprint on the printed circuit board. The numbers of the following paragraphs are labeled in the diagram:

- ❶ Must maintain a solder mask web between pads when traces are routed between the pads on the same layer. Solder mask may not encroach onto the pads within the pad dimension shown.
- ❷ Via in pad not allowed on these pads. Via edges may be tangent to pad edges as long as solder mask web between vias and pads is maintained.
- ❸ Permissible surface finishes on pad are HASL, immersion silver, or gold over nickel.
- ❹ Footprint is compatible with retention model E5396-68702.
- ❺ Retention module dimensions are 20.04 mm x 6.99 mm x 4.95 mm tall relative to the top surface of the PCB. Retention pins extend 27.18mm beyond the bottom surface of the RM through the PCB.

2 Using Probe Heads

N2887A/8A Soft Touch Probe Heads

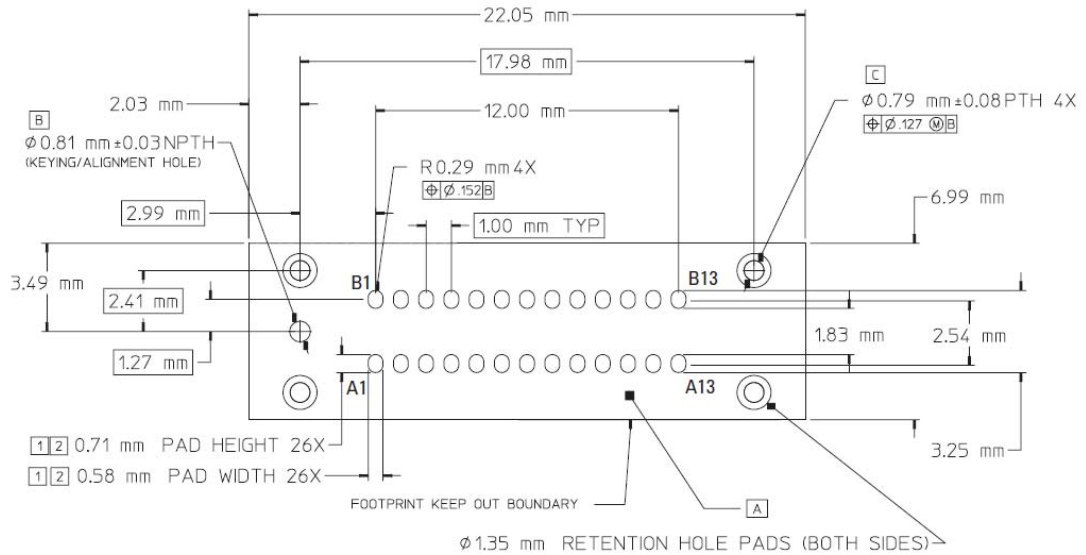

Figure 66 N2888A Footprint Dimensions

Pin-Outs

The N2887A probe head contains 36 single connections and 18 dedicated ground connections as shown in [Figure 67](#) on page 101. The arrangement of signals (differential, single-ended, clocks) is definable by the user. The signal and ground connections of the N2887A are arranged so they are compatible with the Agilent Pro Series Soft Touch logic probe footprint (E5402A, E5404A, E5405A, and E5406A). When probing an existing Pro Series Soft Touch footprint, refer to the Agilent *E5400-Pro Series Soft Touch Connectorless Probes User's Guide* for specifics about signal and clock locations.

The N2888A half-channel probe head contains 18 single connections and 8 dedicated ground connections. This is shown in [Figure 68](#) on page 102. You can define the arrangement of signals (differential, single-ended, clocks). The signal and ground connections of the N2887A are arranged so they are compatible with the Agilent

Half-Channel Series Soft Touch logic probe footprint (E5396A and E5398A). When probing an existing Half-Channel Series Soft Touch footprint, refer to the Agilent *E5400-Pro Series Soft Touch Connectorless Probes User's Guide* for specifics about signal and clock locations.

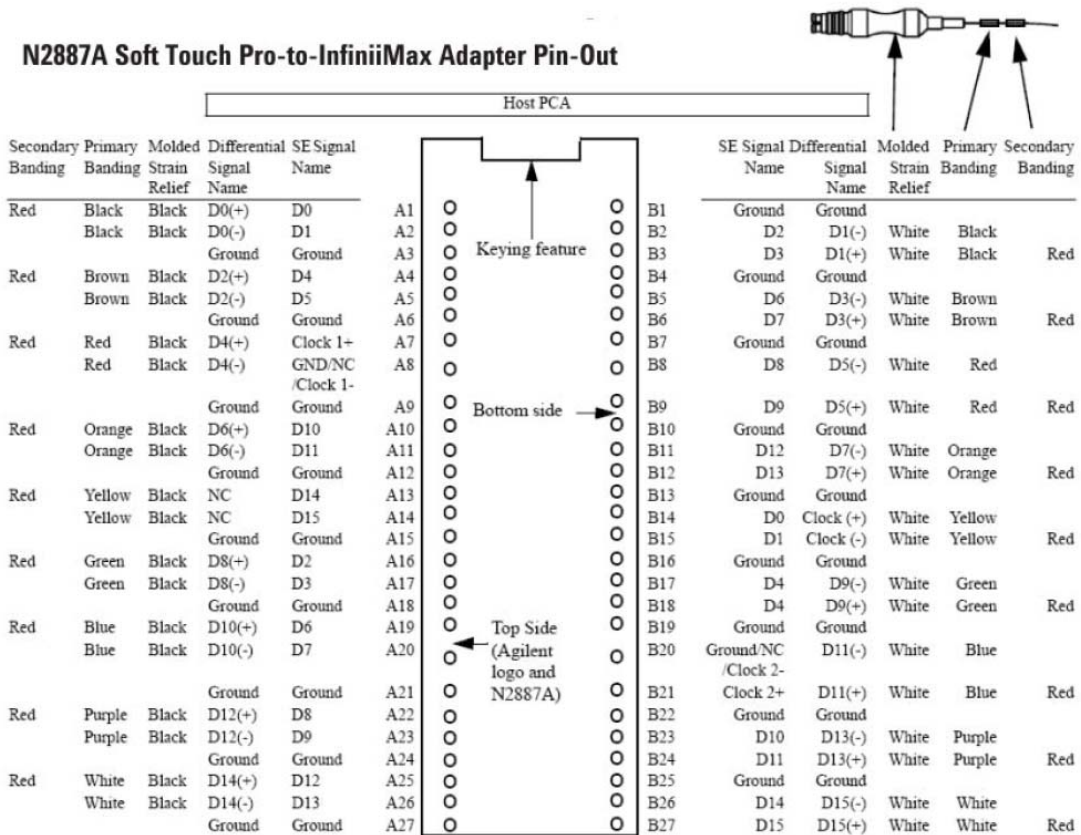

Figure 67 Pin Outs for N2887A Soft Touch Pro

2 Using Probe Heads
N2887A/8A Soft Touch Probe Heads

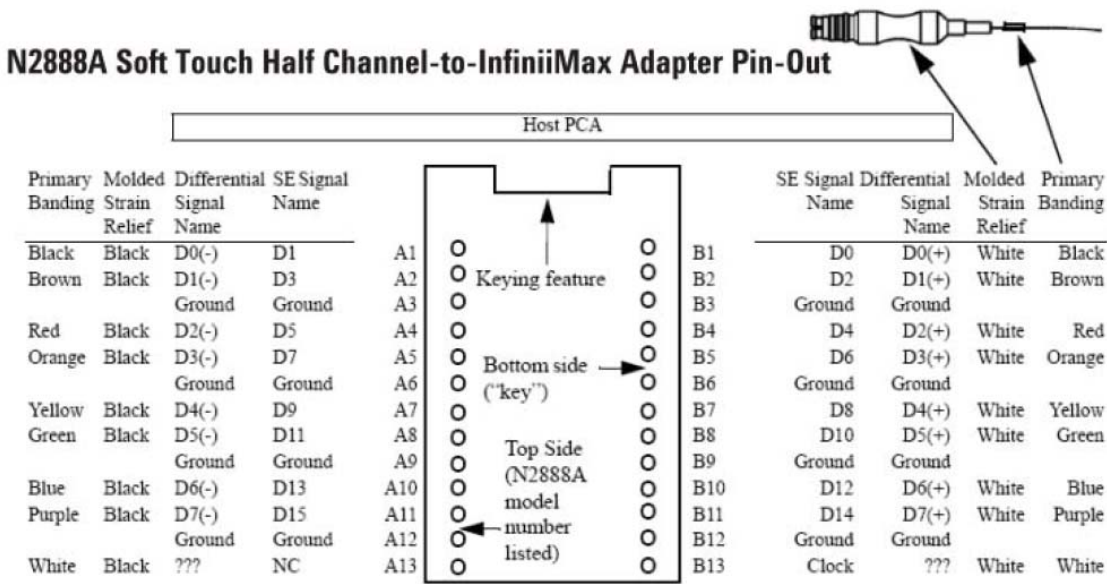
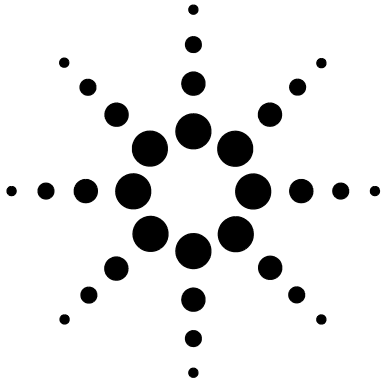

Figure 68 Pin Outs for N2888A Soft Touch Half-Channel



3

Maintaining Probe Heads

N5381/2A Probe Heads	104
N5451A Long-Wired ZIF Tips	109
E2677A/9A Solder-In Probe Heads	113

Many probe heads come equipped with replaceable resistor tips. If these resistor tips break, you can replace the tips without having to replace the entire probe head or having to send it back for repair. This chapter shows you how to install or repair the leads on the following probe heads and tips.

- N5381A differential solder-in probe head
- N5382A differential browser probe head
- N5451A long-wired ZIF tips for the N5425A ZIF probe head
- E2677A differential solder-in probe head
- E2679A single-ended solder-in probe head



N5381/2A Probe Heads

Use the following procedure to install or replace the wire leads of the N5381A solder-in and N5382A browser probe heads. Use the appropriate wire for each probe head as listed in [Table 16](#).

Table 16 Required Wire Type

Wire Diameter	Part Number	N5381A Probe Head	N5382A Probe Head
0.007 inch (tin-plated nickel wires)	01169-81301	✓	
0.005 inch (tin-plated nickel wires)	01169-21306	✓	
0.005 inch (tin-plated steel wires)	01169-21304		✓

Table 17 Recommended Equipment

Equipment
Vise or clamp for holding tip
Metcal STTC-022 (600 °C) or STTC-122 (700 °C) tip soldering iron or equivalent. The 600 °C tip will help limit burning of the FR4 tip PC board.
0.381 mm (0.015 in) diameter RMA flux standard tin/lead solder wire
Fine stainless steel tweezers
Rosin flux pencil, RMA type (Kester #186 or equivalent)
Flush cutting wire cutters
Magnifier or low power microscope
Agilent supplied trim gauge (01169-23801)

Procedure

- 1 Use the vise or clamp to position the tip an inch or so off the work surface for easy access.

CAUTION

If using a vise, grip the tip on the sides with light force. When tightening the vise, use light force to avoid damaging the solder-in probe head. If using a tweezers clamp, grip the tip either on the sides or at the top and bottom.

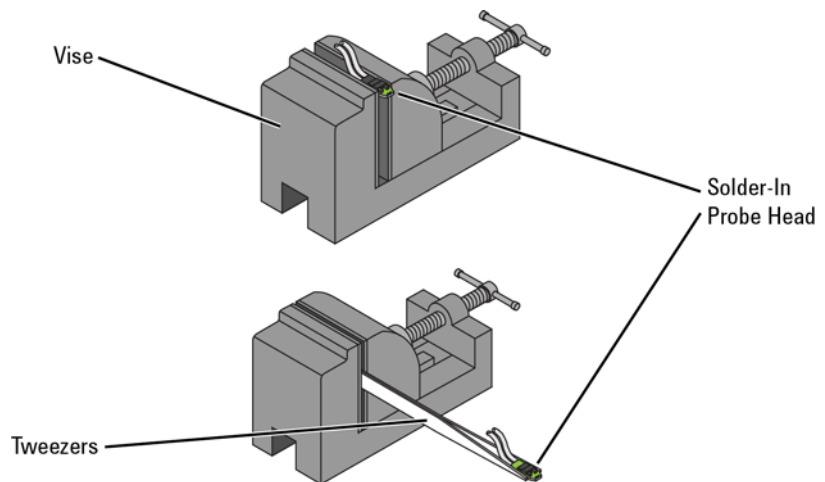

Figure 69 Clamping the Probe Head

- 2 If you need to remove an existing or damaged lead wire, grab the wire lead with tweezers and pull very gently up. Touch the soldering iron to the solder joint just long enough for the wire to come free of the probe head tip.

CAUTION

To avoid burning and damage to the pc board, do not keep the soldering iron in contact with the tip any longer than necessary. The solder joint has very low thermal mass, so the joint quickly melts and releases the wire.

NOTE

Make sure soldering iron tip is free of excess solder.

3 Maintaining Probe Heads

N5381/2A Probe Heads

- 3 In needed, fill the mounting hole with solder in preparation for the new wire.
- 4 Use the flux pencil to coat the solder joint area with flux.
- 5 Cut two wires to a length of about 12.7 mm (0.5 inches).
- 6 Using tweezers, put a 90° bend at the end of the wire. Leave enough wire at the bend such that it will protrude through the board when the wire is installed.

Trim each wire lead 0.89 mm to fit the hole in the pc board as shown in figure 70. Do not trim the lead length until the end of this procedure, where a trim gauge is used.

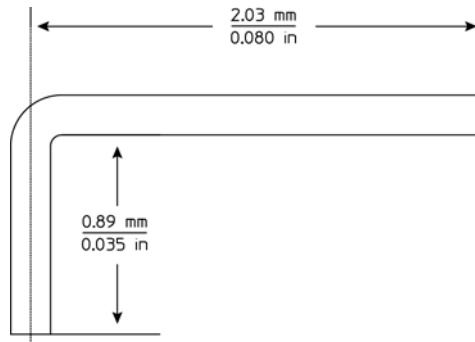

Figure 70 Wire Lead Trim Dimensions

- 7 Holding the wire in one hand and the soldering iron in the other hand, position the end of the wire lead over the solder filled hole. Touch the soldering iron to the side of the hole. When the solder in the hole melts, the wire lead will fall into the hole. Remove soldering iron as soon as lead falls into the hole.

CAUTION

The thermal mass of the joint is very small, so taking extra time with the soldering iron in an attempt to ensure a good joint is not needed.

- 8 Cut the wires that protrude on the bottom side of the probe head board even with the solder pad.

Cut flush with
solder pad.



Figure 71 Wire Cut Flush with Solder pad

- 9 Place the wires through the hole in the trim gauge with the probe head perpendicular to the trim gauge.

Trim Gauge

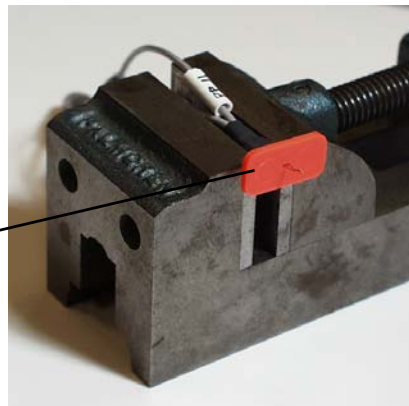

Figure 72 Trim Gauge on Probe Head

- 10 Cut the wires even with the trim gauge on the side opposite of the probe head.

3 Maintaining Probe Heads N5381/2A Probe Heads



Figure 73 Cutting Wires Flush with Gauge

- 11 When replacing wires on the N5382A Browser, bend the wires down at about a 30° angle.

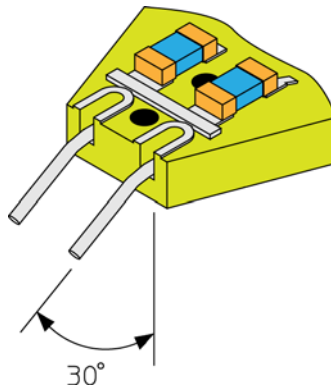

Figure 74 Wires Bent 30°

N5451A Long-Wired ZIF Tips

Use the following procedure to install or replace the long-wired 91Ω resistor lead. To properly trim and shape the lead, use the Agilent supplied trim template that is included as part of the N5451A packaging.

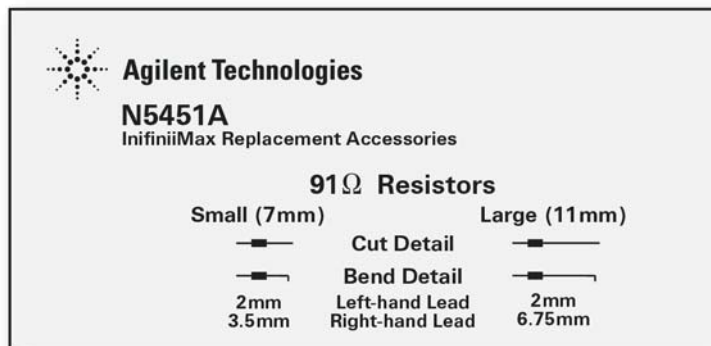

Figure 75 N5451A Trim Template (N5451-94301)

- 1** Using tweezers, place resistor body on the trim template. The trim template contains two lengths: 7 mm and 11 mm. Choose the correct length for your application.

NOTE Place resistor body over the outline of the resistor on shown the template.

3 Maintaining Probe Heads N5451A Long-Wired ZIF Tips

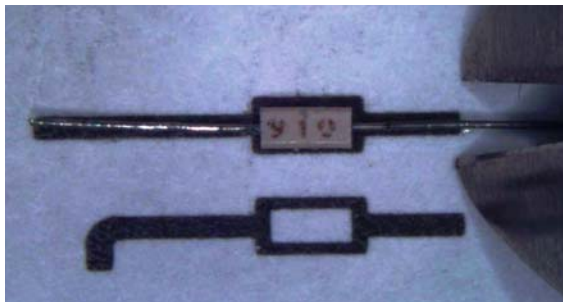

Figure 76 Resistor Placed on the Cut Detail Outline

- 2 Using the X-acto knife, trim the leads even with the trim lines.
- 3 Using another pair of tweezers, bend the right-hand lead 90°.

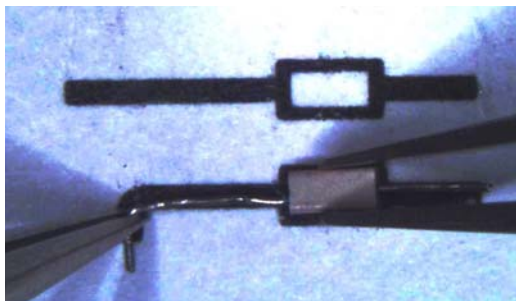

Figure 77 Resistor Placed on the Bend Detail Outline

- 4 If you need to remove an existing or damaged lead wire, grab the wire lead with tweezers and pull very gently up. Touch the soldering iron to the solder joint just long enough for the wire to come free of the probe head tip.

CAUTION

To avoid burning and damage to the pc board, do not keep the soldering iron in contact with the tip any longer than necessary. The solder joint has very low thermal mass, so the joint quickly melts and releases the wire.

NOTE

Make sure soldering iron tip is free of excess solder.

- 5 Use a flux pen to add flux to the circular traces on the board.

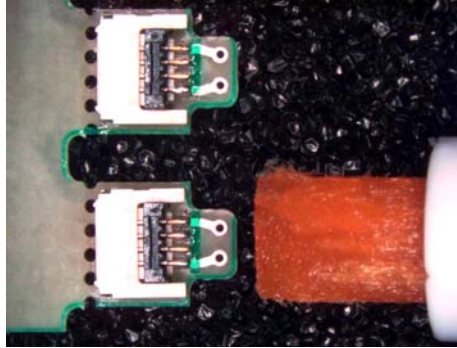

Figure 78 Adding Flux

- 6 Insert one resistor into each through-hole of the circular traces on the board. Align the corresponding resistor faces as shown in [Figure 79](#). Make length adjustments as needed.

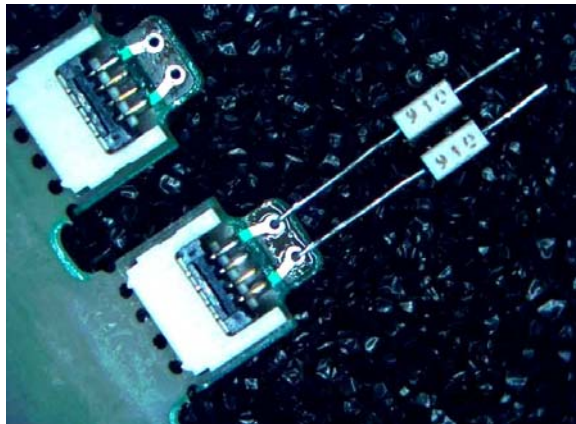

Figure 79 Resistors Inserted into Tip

- 7 Momentarily apply the soldering iron tip to the resistor lead wires as shown in [Figure 80](#). Touch the solder to the heated lead wire near the trace hole. A good fillet should form around the lead wire, thus sealing the trace hole. [Figure 81](#)

3 Maintaining Probe Heads N5451A Long-Wired ZIF Tips

shows good solder fillets surrounding the resistor lead wires. After soldering, clean board of any excess flux. On the ZIF Tip's opposite side, trim any excess lead wire protruding from the board.

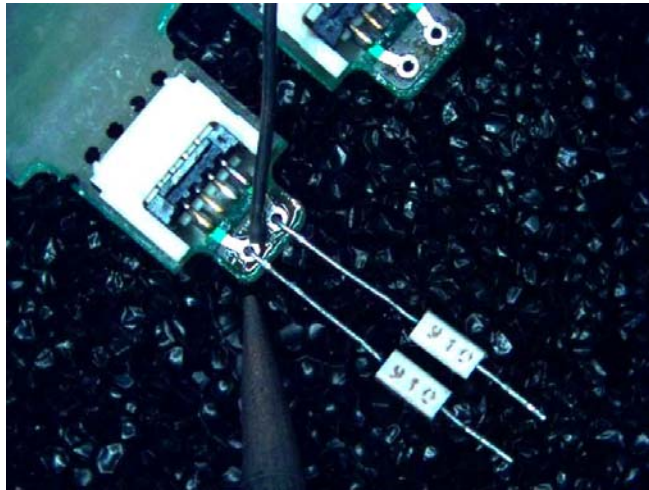

Figure 80 Soldering the Resistors

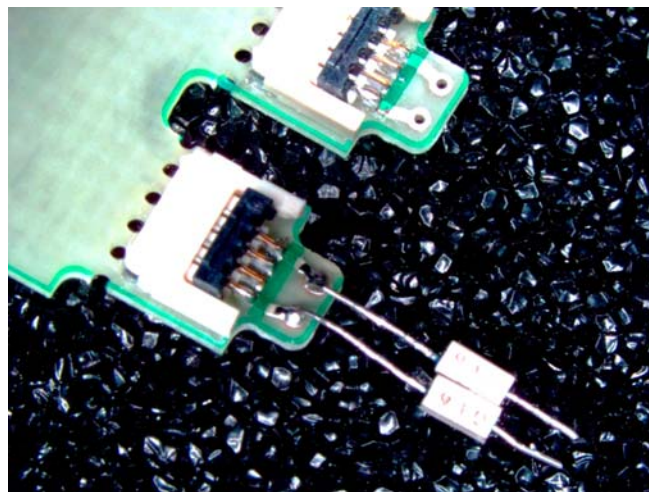

Figure 81 Solder Fillets Surrounding the Resistor Lead Wires

E2677A/9A Solder-In Probe Heads

Use the following procedure to install or replace the wire leads when the mini-axial resistors become damaged or break off due to use.

Table 18 Resistors and Bandwidth

Resistor	For Bandwidth
91Ω	Full
150Ω	Medium
0Ω	Full and Medium

Table 19 Recommended Equipment

Equipment
Vise or clamp for holding tip
Metcal STTC-022 (600 °C) or STTC-122(700 °C) tip soldering iron or equivalent. The 600 °C tip will help limit burning of the FR4 tip PC board.
0.381 mm (0.015 in) diameter RMA flux standard tin/lead solder wire
Fine stainless steel tweezers
Rosin flux pencil, RMA type (Kester #186 or equivalent)
Diagonal cutters
Magnifier or low power microscope
Agilent supplied trim gauge (01131-94311)

3 Maintaining Probe Heads

E2677A/9A Solder-In Probe Heads

Procedure

- 1 Use the vise or clamp to position the tip an inch or so off the work surface for easy access.

CAUTION

If using a vise, grip the tip on the sides with light force. When tightening the vise, use light force to avoid damaging the solder-in probe head. If using a tweezers clamp, grip the tip either on the sides or at the top and bottom.

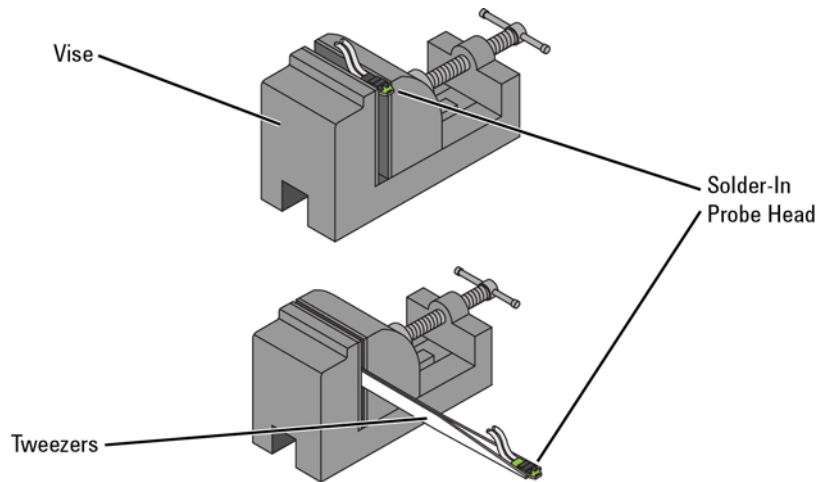

Figure 82 Clamping the Probe Head

- 2 If you need to remove an existing or damaged lead wire, grab each resistor lead or body with tweezers and pull very gently up. Touch the soldering iron to the solder joint just long enough for the resistor to come free of the probe head tip.

CAUTION

To avoid burning and damage to the pc board, do not keep the soldering iron in contact with the tip any longer than necessary. The solder joint has very low thermal mass, so the joint quickly melts and releases the wire.

NOTE

Make sure soldering iron tip is free of excess solder.

- 3 In needed, fill the mounting hole with solder in preparation for the new wire.
- 4 Use the flux pencil to coat the solder joint area with flux.
- 5 Prepare the mini-axial lead resistor for attachment to the head's pc board. The lead to be attached to head's pc board will have a 90° bend to go into through hole in the tip pc board.
- 6 Using tweezers, place the resistor body inside the rectangle of the trim template.

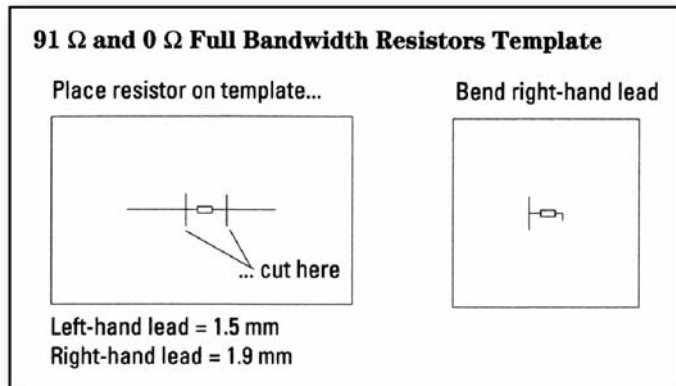

Figure 83 Agilent Supplied Template Included With Resistors

- 7 Using the X-acto knife, trim the leads even with the trim lines.
- 8 Place resistor body inside the rectangle of the bend template.
- 9 Using another pair of tweezers, bend the 1.90 mm or 8.89 mm lead 90° as shown in [Figure 84](#) and [Figure 85](#).

3 Maintaining Probe Heads

E2677A/9A Solder-In Probe Heads

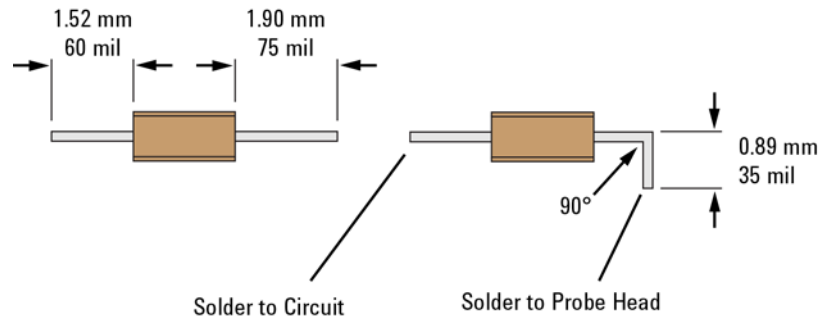

Figure 84 91 Ω and 0 Ω Combination Resistor Trim Dimensions

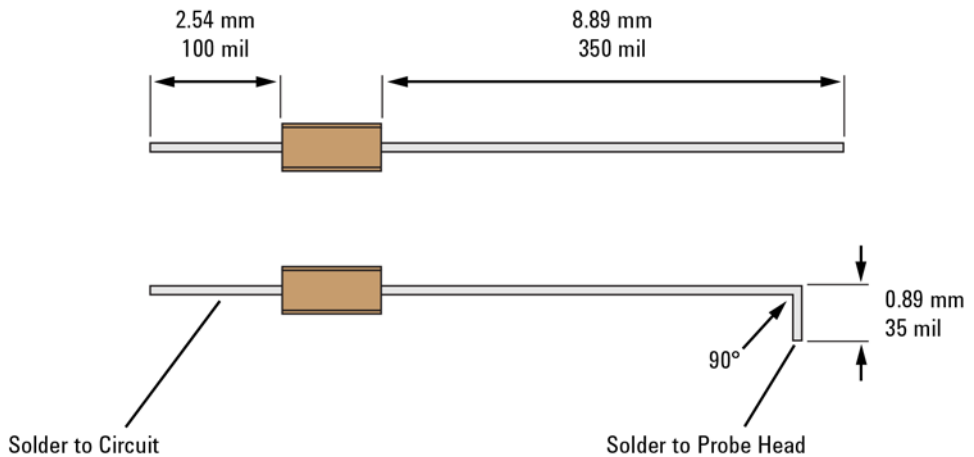

Figure 85 150 Ω and 0 Ω Combination Resistor Trim Dimensions

NOTE

Do not use the wrong value of resistor at the wrong length.

- 10 Holding the resistor lead or wire in one hand and soldering iron in the other, position the end of the resistor lead (after the 90° bend) over the solder filled hole. Touch the soldering iron to the side of the hole. When the solder in the hole

melts, the resistor lead will fall into the hole. Remove soldering iron as soon as lead falls into the hole.

CAUTION

The thermal mass of the joint is very small, so taking extra time with the soldering iron in an attempt to ensure a good joint is not needed.

NOTE

Make sure the zero ohm resistor is used for ground leads on the E2679A single-ended probe head.

NOTE

For the E2677A differential solder-in probe head, the + and – connection can be determined when the probe head is plugged into the probe amplifier, so which way the tip is soldered in is not important.

3 **Maintaining Probe Heads**
E2677A/9A Solder-In Probe Heads

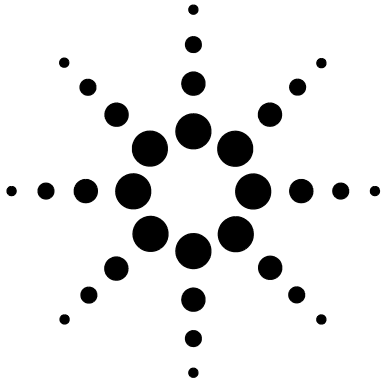

4

Calibrating Probes

DC Gain and Offset Calibration	120
Calibration for Solder-In and Socketed Probe Heads	121
Calibration for Hand-Held Browser Probe Heads	129
N2887A & N2888A Calibration and Deskew Procedure	131

This document contains procedures for vertical and skew calibration of the solder-in differential probe head and the differential browser probe head. The procedures can also be applied to all of the different InfiniiMax probe configurations.



DC Gain and Offset Calibration

The Infiniium family of oscilloscopes provides both power and offset control to the 1168A and 1169A active probes through the front-panel connector. Probe offset is changed by adjusting the vertical offset control on the Infiniium oscilloscope. The control should be adjusted to center your signal within the 3.3V peak-to-peak (16V peak-to-peak for slow signals) dynamic range of the probe.

This calibration and deskew should be performed *before* using the probe.

Procedure

- 1 Connect the probe output to the oscilloscope input.
- 2 Calibrate the oscilloscope and probe combination using the Infiniium probe calibration routine.

When the probe has been calibrated, the dc gain, offset zero, and offset gain will be calibrated. The degree of accuracy specified at the probe tip is dependent on the oscilloscope system specifications.

Calibration for Solder-In and Socketed Probe Heads

Calibration of the solder-in and socketed probe heads consists of a vertical calibration and a skew calibration. The vertical calibration should be performed before the skew calibration. Both calibrations should be performed for best probe measurement performance.

NOTE

Before calibrating the probe, verify that the Infiniium oscilloscope has been calibrated recently and that the calibration D temperature is within $\pm 5^{\circ}\text{C}$. If this is not the case, calibrate the oscilloscope before calibrating the probe. This information is found in the Infiniium Calibration dialog box.

Step 1. Connecting the Probe for Calibration

The calibration procedure requires the following parts.

- BNC (male) to SMA (male) adaptor
- Deskew fixture
- 50Ω SMA terminator

- 1 As shown in [Figure 86](#) on page 123, connect BNC (male) to SMA (male) adapter to the deskew fixture on the connector closest to the yellow pincher.
- 2 Connect the 50Ω SMA terminator to the connector farthest from the yellow pincher.
- 3 Connect the BNC side of the deskew fixture to the Aux Out BNC of the Infiniium oscilloscope.
- 4 Connect the probe to an oscilloscope channel.
- 5 To minimize the wear and tear on the probe head, the probe head should be placed on a support to relieve the strain on the probe head cables.
- 6 Push down on the back side of the yellow pincher. Insert the probe head resistor lead underneath the center of the yellow pincher and over the center conductor of the deskew fixture. The negative probe head resistor lead or ground lead must

4 Calibrating Probes

Calibration for Solder-In and Socketed Probe Heads

be underneath the yellow pincher and over one of the outside copper conductors (ground) of the deskew fixture. Make sure that the probe head is approximately perpendicular to the deskew fixture.

NOTE

For the socketed probe head, insert two properly trimmed 82 Ω resistors into the sockets.

7

Release the yellow pincher.

NOTE

To ensure contact, pull up on the back side of the yellow pincher to ensure good contact between resistor leads and the deskew fixture.

Step 2. Verifying the Connection

- 1 On the oscilloscope, press the autoscale button on the front panel.
- 2 Set the volts per division to 100 mV/div.
- 3 Set the horizontal scale to 1.00 ns/div.
- 4 Set the horizontal position to approximately 3 ns. You should see a waveform similar to that in [Figure 87](#).

If you see a waveform similar to that of [Figure 88](#), then you have a bad connection and should check all of your probe connections.

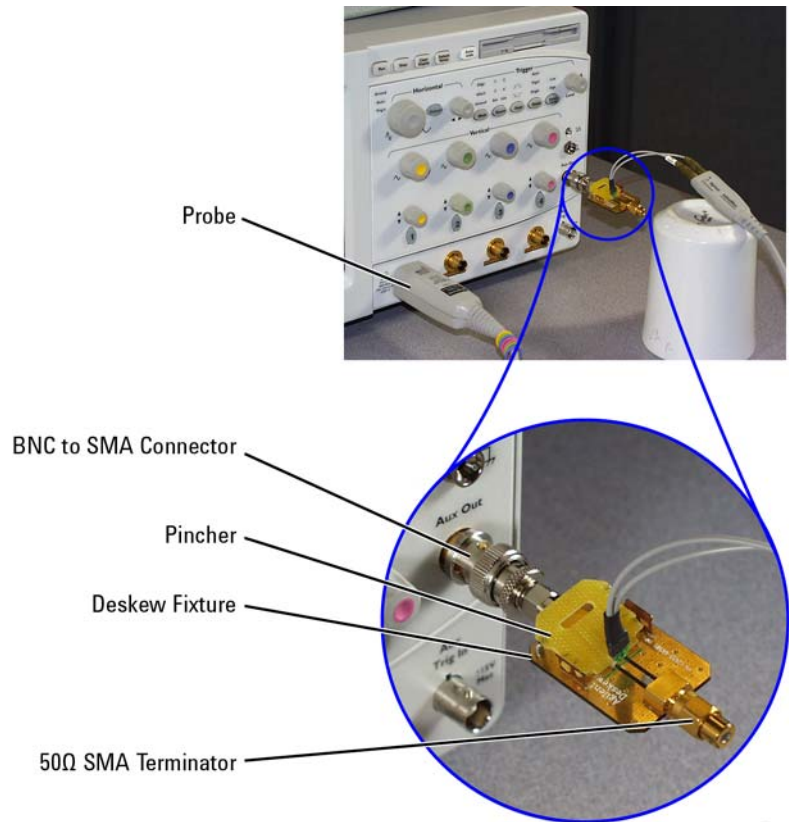

Figure 86 Connecting the Probe and Deskew Fixture

4 Calibrating Probes

Calibration for Solder-In and Socketed Probe Heads



Figure 87 Good Connection

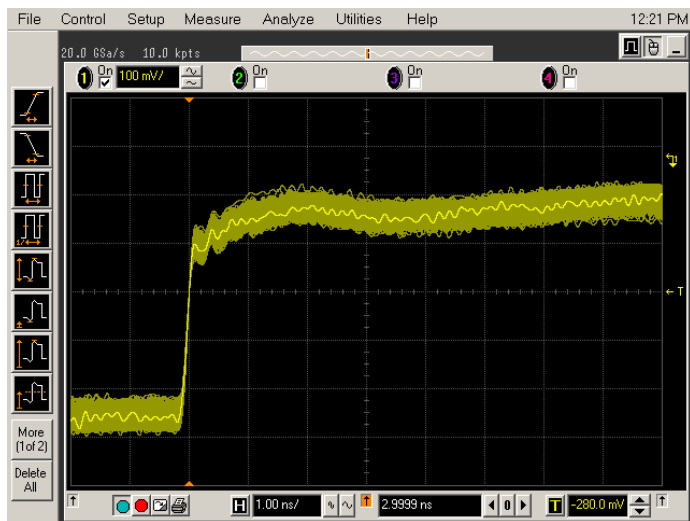

Figure 88 Bad Connection

Step 3. Running the Probe Calibration and Deskew

- 1 On the Infiniium oscilloscope in the Setup menu, select the channel connected to the probe.
- 2 In the Channel Setup dialog box select the Probes... button.
- 3 In the Probe Setup dialog box select the Calibrate Probe... button.
- 4 In the Probe Cal dialog box select the Calibrated Atten/Offset radio button.
- 5 Select the Start Atten/Offset Calibration... button and follow the on-screen instructions for the vertical calibration procedure.
- 6 Once the vertical calibration has successfully completed, select the Calibrated Skew... button.
- 7 Select the Start Skew Calibration... button and follow the on-screen instructions for the skew calibration. At the end of each calibration the oscilloscope will inform you if the calibration was or was not successful.

Verifying the Probe Calibration

If you have just successfully calibrated the probe, it is not necessary to perform this verification. However, if you want to verify the probe was properly calibrated, the following procedure will help you verify the calibration.

The calibration procedure requires the following parts.

- BNC (male) to SMA (male) adaptor
- SMA (male) to BNC (female) adaptor
- BNC (male) to BNC (male) 12 inch cable such as the Agilent 8120-1838 (not included in this kit)
- Agilent 54855-61620 calibration cable (Infiniium oscilloscopes with bandwidths of 6 GHz and greater only)
- Agilent 54855-67604 precision 3.5 mm adaptors (Infiniium oscilloscopes with bandwidths of 6 GHz and greater only)
- Deskew fixture

4 Calibrating Probes

Calibration for Solder-In and Socketed Probe Heads

For the following procedure, refer to [Figure 86](#) on page 123.

- 1 As shown in [Figure 89](#) on page 127, connect BNC (male) to SMA (male) adaptor to the deskew fixture on the connector closest to the yellow pincher.
- 2 Connect the SMA (male) to BNC (female) to the connector farthest from the yellow pincher.
- 3 Connect the BNC (male) to BNC (male) cable to the BNC connector on the deskew fixture to one of the unused oscilloscope channels. For Infiniium oscilloscopes with bandwidths of 6 GHz and greater, use the 54855-61620 calibration cable and the two 54855-67604 precision 3.5 mm adaptors.
- 4 Connect the BNC side of the deskew fixture to the Aux Out BNC of the Infiniium oscilloscope.
- 5 Connect the probe to an oscilloscope channel.
- 6 To minimize the wear and tear on the probe head, the probe head should be placed on a support to relieve the strain on the probe head cables.
- 7 Push down on the back side of the yellow pincher. Insert the probe head resistor lead underneath the center of the yellow pincher and over the center conductor of the deskew fixture. The negative probe head resistor lead or ground lead must be underneath the yellow pincher and over one of the outside copper conductors (ground) of the deskew fixture. Make sure that the probe head is approximately perpendicular to the deskew fixture.

NOTE

For the socketed probe head, insert two properly trimmed 82 Ω resistors into the sockets.

-
- 8 Release the yellow pincher.

NOTE

To ensure contact, pull up on the back side of the yellow pincher to ensure good contact between resistor leads and the deskew fixture.

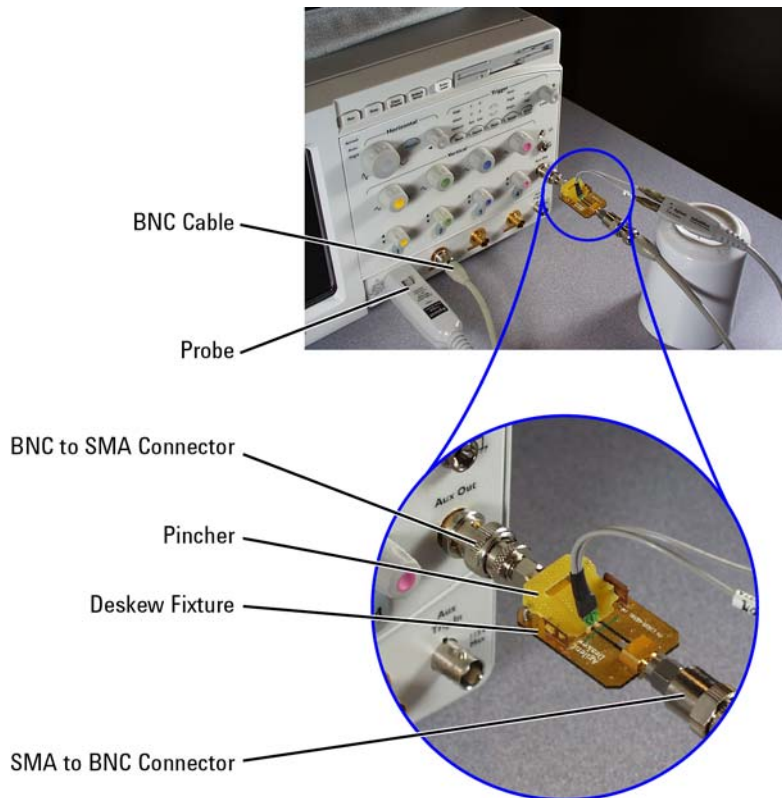

Figure 89 Connecting the Probe

- 9 On the oscilloscope, press the autoscale button on the front panel.
- 10 Select Setup menu and choose the channel connected to the BNC cable from the pull-down menu.
- 11 Select the Probes... button.
- 12 Select the Configure Probe System button.
- 13 Select User Defined Probe from the pull-down menu.
- 14 Select the Calibrate Probe... button.
- 15 Select the Calibrated Skew radio button.

4 Calibrating Probes

Calibration for Solder-In and Socketed Probe Heads

- 16 Once the skew calibration is completed, close all dialog boxes.
- 17 Select the Start Skew Calibration... button and follow the on-screen instructions.
- 18 Set the vertical scale for the displayed channels to 100 mV/div.
- 19 Set the horizontal range to 1.00 ns/div.
- 20 Set the horizontal position to approximately 3 ns.
- 21 Change the vertical position knobs of both channels until the waveforms overlap each other.
- 22 Select the Setup menu choose Acquisition... from the pull-down menu.
- 23 In the Acquisition Setup dialog box enable averaging. When you close the dialog box, you should see waveforms similar to that in Figure 90.

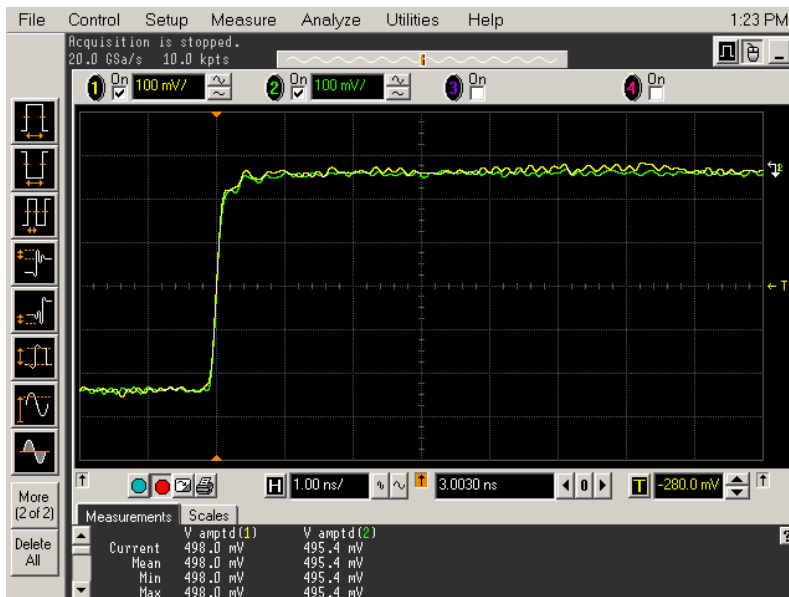

Figure 90 Overlapping Waveforms

Calibration for Hand-Held Browser Probe Heads

Calibration of the hand-held browser probe heads consists of a vertical calibration and a skew calibration. The vertical calibration should be performed before the skew calibration. Both calibrations should be performed for best probe measurement performance.

NOTE

Before calibrating the probe, verify that the Infiniium oscilloscope has been calibrated recently and that the calibration Δ temperature is within ± 5 °C. If this is not the case, calibrate the oscilloscope before calibrating the probe. This information is found in Infiniium Calibration dialog box.

Calibration Setup

The calibration procedure requires the following parts.

- BNC (male) to SMA (male) adaptor
- Deskew fixture
- 50 Ω SMA terminator

- 1 As shown in [Figure 91](#) on page 130, connect BNC (male) to SMA (male) adaptor to the deskew fixture on the connector closest to the yellow pincher.
- 2 Connect the 50 Ω SMA terminator to the connector farthest from the yellow pincher.
- 3 Connect the BNC side of the deskew fixture to the Aux Out of the Infiniium oscilloscope.
- 4 Connect the probe to an oscilloscope channel.
- 5 Place the positive resistor tip of the browser on the center conductor of the deskew fixture between the green line and front end of the yellow pincher. The negative resistor tip or ground pin of the browser must be on either of the two outside conductors (ground) of the deskew fixture.
- 6 On the Infiniium oscilloscope in the Setup menu, select the channel connected to the probe.

4 Calibrating Probes

Calibration for Hand-Held Browser Probe Heads

- 7 In the Channel Setup dialog box select the Probes... button.
- 8 In the Probe Setup dialog box select the Calibrate Probe... button.
- 9 In the Probe Cal dialog box select the Calibrated Atten/Offset radio button.
- 10 Select the Start Atten/Offset Calibration... button and follow the on-screen instructions for the vertical calibration procedure.
- 11 Once the vertical calibration has successfully completed, select the Calibrated Skew... button.
- 12 Select the Start Skew Calibration... button and follow the on-screen instructions for the skew calibration.

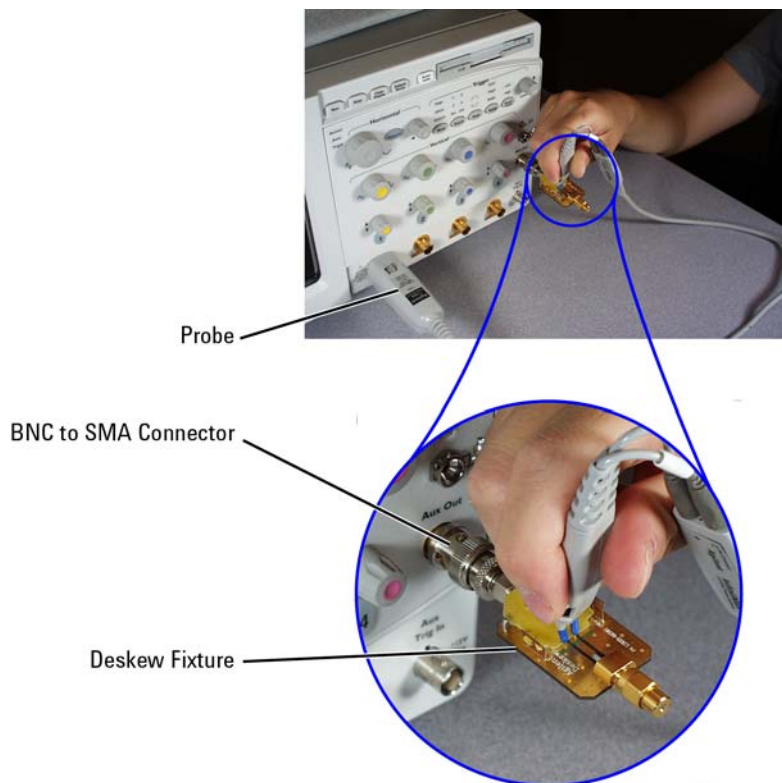

Figure 91 Placing the Probe on the Fixture

N2887A & N2888A Calibration and Deskew Procedure

The N2887-60002 Calibration/Deskew kit contains the following parts. The last three items in the list are required for the calibration procedure.

- BNC (male) to SMA (male) adapter
- SMA (male) to BNC (female) adapter
- SMA (male) to SMA (male) adapter
- 50Ω SMA terminator
- Deskew Fixture



Calibration of the N2887A/N2888A probe heads consists of a vertical calibration and a skew calibration. The vertical calibration should be performed before the skew calibration. Both calibrations should be performed for best probe measurement performance.

NOTE

Before calibrating the probe, verify that the Infiniium oscilloscope has been recently calibrated and that the calibration change in temperature is ± 5 °C. If this is not the case, calibrate the oscilloscope before calibrating the probe. This information is found in the Infiniium Calibration dialog box.

4 Calibrating Probes

N2887A & N2888A Calibration and Deskew Procedure

Connecting the Probe for Calibration

- 1 Connect the BNC (male) to SMA (male) adapter to the deskew fixture on the connector (it does not matter which connector you use).
- 2 Connect the 50Ω SMA terminator to the other connector on the deskew fixture.
- 3 Connect the BNC side of the deskew fixture to the Cal Out BNC on the Infiniium oscilloscope.
- 4 Connect either the N2887A or N2888A probe head to the deskew fixture as shown in the [Figure 92](#) on the following page (note: use the appropriate connector for either the N2887A or N2888A model as shown on the following page).

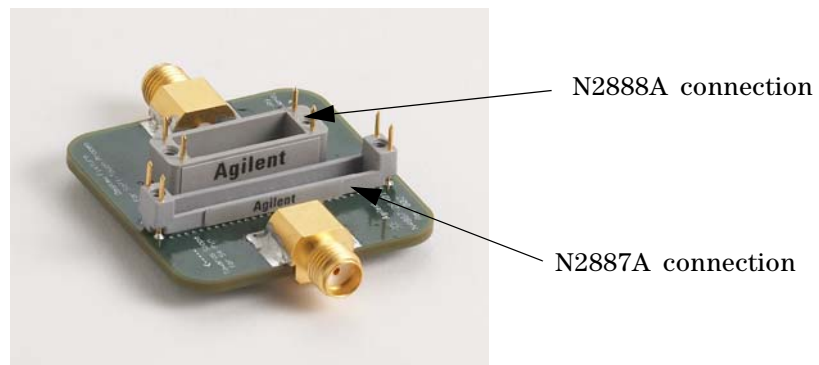

Figure 92 Deskew Fixture with N2887/8A Connections

- 5 Connect the InfiniiMax probe amplifier to an oscilloscope channel.
- 6 Connect one of the leads from the probe head to the positive terminal on the InfiniiMax probe amplifier. The lead you will use depends on whether you are using the N2887A or N2888A probe head:

N2887A & N2888A Calibration and Deskew Procedure

- For the N2887A probe head, use the connection with the white molded strain relief and the yellow primary banding.
- For the N2888A probe head, use the connection with the black molded strain relief and yellow primary banding.



NOTE

To minimize the wear and tear on the probe head, the probe head should be placed on a support to relieve the strain on the probe head cables.

NOTE

Please note that you are only deskewing one channel on the InfiniiMax Soft Touch probe head in this procedure. The other channels are nominally identical (< 15 ps). The major source of skew when using multiple InfiniiMax amplifiers with a single InfiniiMax Soft Touch probe head is the variations from one amplifier to another. This skew can be addressed by repeating the procedure outlined above for each InfiniiMax amplifier that will be used.

NOTE

Once you have the probe head connected correctly, perform a normal probe calibration as described in the Infiniium help system available on the oscilloscope.

4 **Calibrating Probes**
N2887A & N2888A Calibration and Deskew Procedure

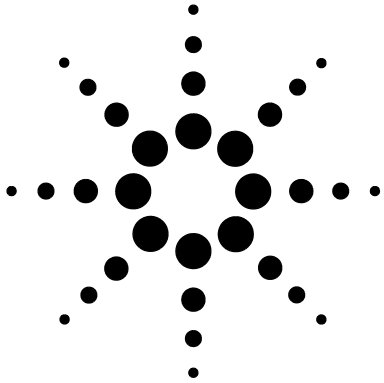

5

Characteristics and Specifications

General 136

InfiniiMax II Series with N5380B SMA Probe Head 139

Environmental 141

Probe Dimensions 142

All characteristics are the typical performance values of the InfiniiMax probes using the probe amplifier and N5381A differential solder-in probe head and are not warranted.



General

CAT I: Secondary Circuits

WARNING

Do not use the probe for measurements within measurement categories II, III and IV.

WEEE Compliance

This product complies with the WEEE Directive (2002/96/EC) marking requirements. The affixed label indicates that you must not discard this electrical/electronic product in domestic household waste.



Product Category: With reference to the equipment types in the WEEE Directive Annex I, this product is classed as a "Monitoring and Control Instrumentation" product.

NOTE

Do not dispose in domestic household waste. To return unwanted products, contact your local Agilent office, or see www.agilent.com for more information.

WARNING

The **RATED** transient overvoltage is 80 volts peak.

Table 20 Specifications

Item	Specification
Bandwidth (–3 dB)	
1168A	> 10 GHz
1169A	> 12 GHz (13 GHz typical)
Input Resistance	
Differential Mode Resistance	50 kΩ ± 2%
Single-Ended Mode Resistance Each Side to Ground	25 kΩ ± 2%

Table 21 Characteristics (Typical Performance) (Sheet 1 of 2)

Item	Characteristic	Description
Bandwidth (–3 dB)		
1168A with DSO/DSA90804A	8 GHz	
1168A with DSO81004A	10 GHz	
1168A with DSO/DSA91204A	12 GHz	
1169A with DSO/DSA91304A	13 GHz	
Rise and Fall Time (10% to 90%)		
1168A	48 ps	
1169A	40 ps	
Rise and Fall Time (20% to 80%)		
1168A	34 ps	
1169A	28 ps	
Rise and Fall Time (10% to 90%) (Phase corrected on DSO90000A Series Oscilloscope)		
1168A	42 ps	
1169A	36 ps	
Rise and Fall Time (20% to 80%) (Phase corrected on DSO90000A Series Oscilloscope)		
1168A	30 ps	
1169A	25 ps	
Input Capacitance		
Cm	0.09 pF	Model for input C is Cm is between tips and Cg is to ground for each tip
Cg	0.26 pF	
Cdiff	0.21 pF	Differential mode capacitance (capacitance when probing a differential signal = Cm + Cg/2)
Cse	0.35 pF	Single-ended mode capacitance (capacitance when probing a single-ended signal = Cm + Cg)
Input Dynamic Range	±1.65V	Differential or single-ended
Input Common Mode Range	±6.75V ±1.25V peak-to-peak	dc to 100 Hz > 100 Hz

5 Characteristics and Specifications

General

Table 21 Characteristics (Typical Performance) (Sheet 2 of 2)

Item	Characteristic	Description
Maximum Signal Slew Rate (SR_{max}) ^a	25 V/ns 40 V/ns	When probing a single-ended signal When probing a differential signal
DC Attenuation	@ 3.45:1 ^b	
Zero Offset Error Referred to Input	< 2 mV x DC attenuation ^b	
Offset Range	±16.0V	When probing single-ended
Offset Accuracy	< 3% ^b	
Noise referred to Input	2.5 mVrms	
Propagation Delay	@ 6 ns	
Maximum Input Voltage	30V Peak, CAT I	Maximum non-destructive voltage on each input ground
ESD Tolerance	> 8 kV from 150 pF, 330Ω HBM	

a SR_{max} of a sine wave = Amp x 2 x π x frequency or SR_{max} of a step @ Amp x 0.6 / trise (20 to 80%). For more information, refer to [Table 7](#) on page 33.

b When calibrated on the oscilloscope, these characteristics are determined by the oscilloscope characteristics.

InfiniiMax II Series with N5380B SMA Probe Head

All characteristics are the typical performance values of the InfiniiMax probes using the probe amplifier and N5380B SMA probe head and are not warranted.

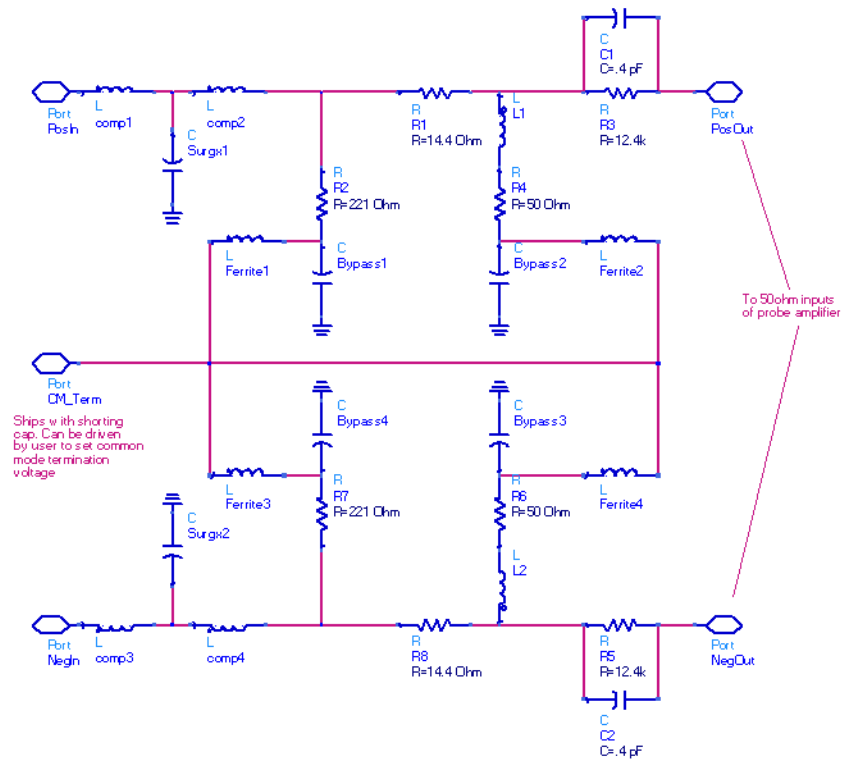

Figure 93 N5380B SMA Probe Head Simplified Schematic

5 Characteristics and Specifications

InfiniiMax II Series with N5380B SMA Probe Head

Table 22 Characteristics

Item	1169A	1168A
Bandwidth	>12GHz	> 10GHz
Probe only rise and fall times	27.5 ps (20% to 80%) 40 ps (10% to 90%)	27.5 ps (20% to 80%) 40 ps (10% to 90%)
System rise and fall times ^a		
	With DSO/DSA91304A: 23 ps (20% to 80%) 33 ps (10% to 90%)	With DSO81004A: 30 ps (20% to 80%) 42 ps (10% to 90%)
	With DSO/DSA91204A 25 ps (20% to 80%) 36 ps (10% to 90%)	With DSO/DSA90804A: 38 ps (20% to 80%) 54 ps (10% to 90%)
System bandwidth (–3 dB)		
	With DSO/DSA91304A: 12.5 GHz	With DSO81004A: 10 GHz
	With DSO/DSA91204A: 12 GHz	With DSO/DSA90804A: 8 GHz
Input Resistance	50Ω ± 2%	
Input Dynamic Range	± 1.1V Differential or Single-Ended	
Maximum Input, (Vin – Vcm_term) ^b	2.28 Vrms	
Input Common Mode Range	± (4.3 V – Vcm_term x 0.29) ± 0.8 V	dc to 100 Hz > 100 Hz
Maximum Signal Slew Rate ^c (SMA attenuator can extend range.) ^d	25 V/ns	Differential Input
DC Attenuation	~2.2:1 (–6.9 dB)	
Zero Offset Error Referred to Input	< 2 mV	
Noise Referred to Input	1.6 mVrms (~ 14 nV/rtHz using noise BW of 12.5 GHz)	
Propagation Delay	~6.15 ns	

- a Decreased rise and fall times mainly due to phase correction performed in the DSO80000 series, not due to DSP boosting (except in DSO81304A).
- b Vcm_term is the voltage supplied to the common mode termination port of the N5380B. If a shorting cap is in place, this voltage is zero.
- c SR max of sine wave = amplitude x 2 x p x frequency OR SR max of a step approximately equal to the amplitude x 0.6/trise (20-80%).
- d Use of X:1 SMA coaxial attenuators in front of SMA probe head will: 1) Increase by X the max input signal slew rate, dynamic range, offset range, common mode range, noise referred to the input, DC attenuation, and maximum input voltage, 2) Most likely improve return loss or input TDR if attenuators are high quality, and 3) Not affect bandwidth and rise time if attenuators are high quality.

Environmental

The following general characteristics apply to the active probe.

Table 23 Environmental Characteristics

Environmental Conditions	Operating	Non-Operating
Temperature	5 °C to +40 °C	–40 °C to +70 °C
Humidity	up to 95% relative humidity (non-condensing) at +40 °C	up to 90% relative humidity at +65 °C
Altitude	Up to 4,600 meters	Up to 15,300 meters
Power Requirements	Voltages supplied by Agilent oscilloscope AutoProbe Interface.	
Weight	approximately 0.69 kg	
Dimensions	Refer to “ Probe Dimensions ” on page 142.	
Pollution degree 2	Normally only non-conductive pollution occurs. Occasionally, however, a temporary conductivity caused by condensation must be expected.	
Use	Indoor Only	

Probe Dimensions

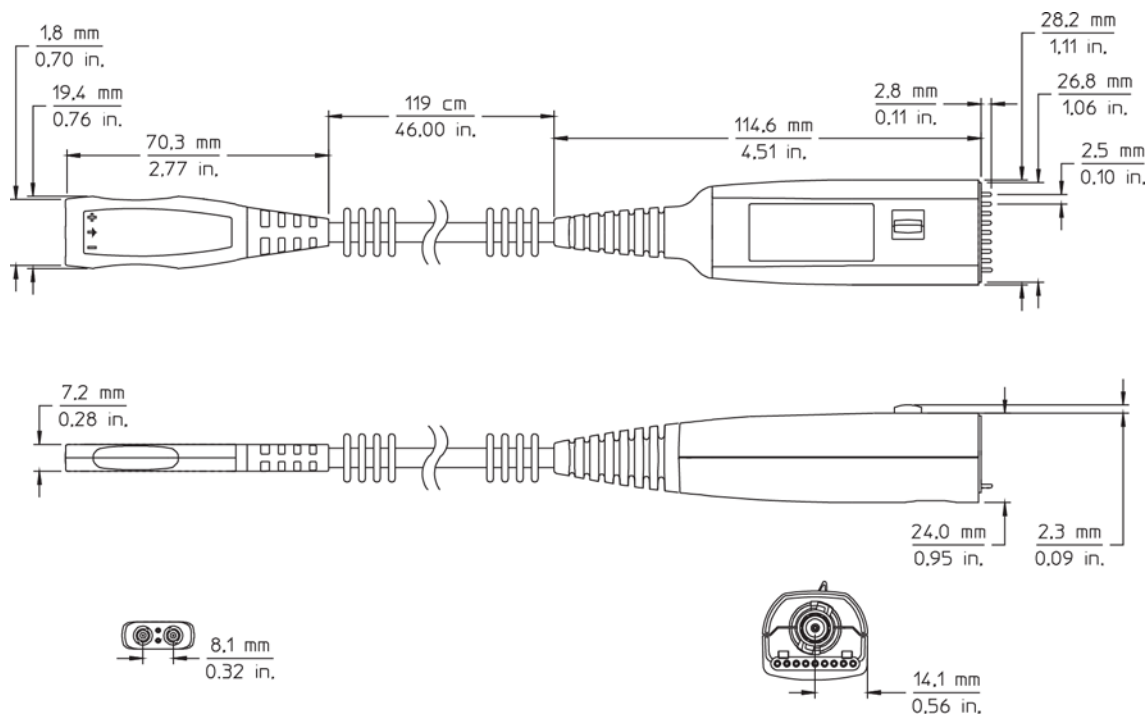

Figure 94 Probe Amplifier Dimensions

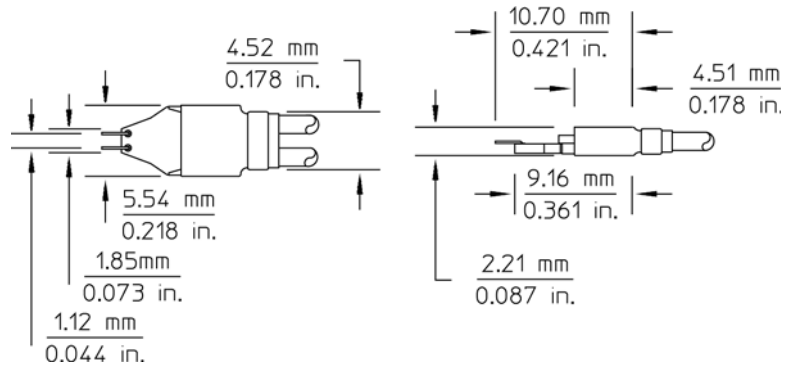

Figure 95 N5381A and N5382A Probe Head Dimensions

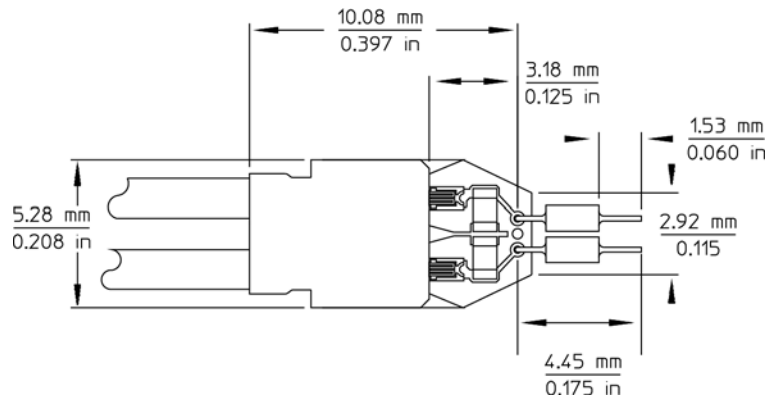

Figure 96 01131-62103 Solder-in Differential Probe Head Dimensions

5 Characteristics and Specifications
Probe Dimensions

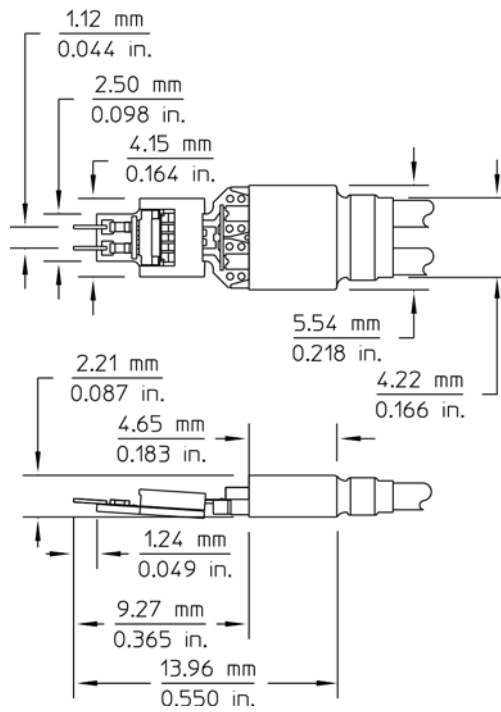
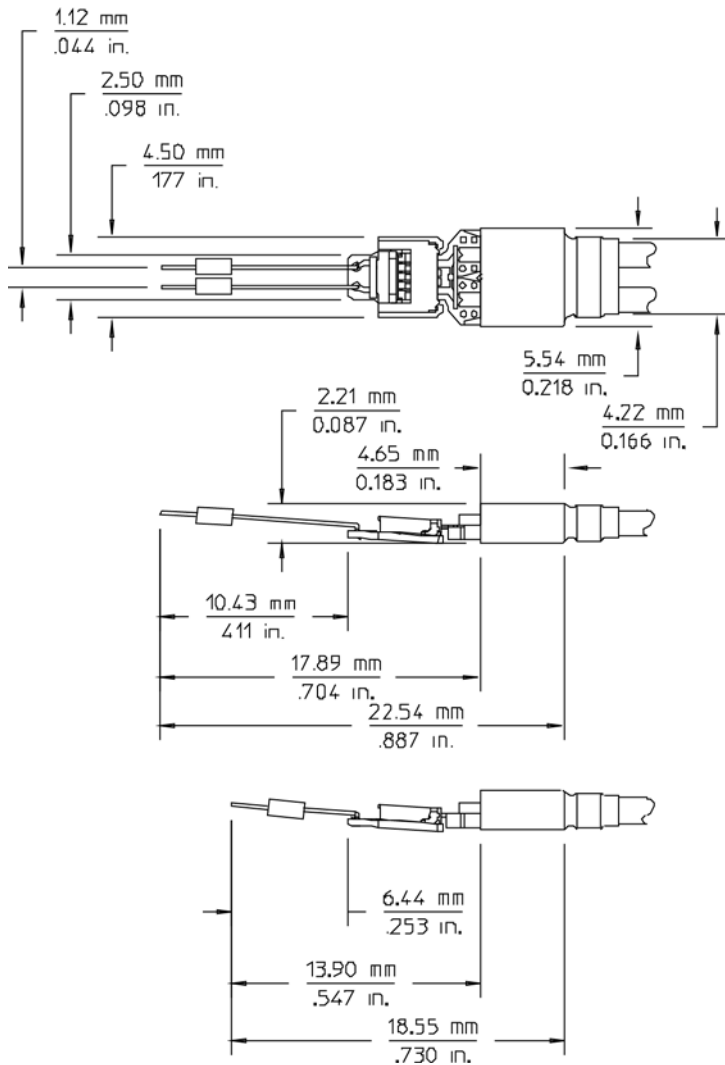

Figure 97 N5425A ZIF Probe Head Dimensions with ZIF Tip Attached



Resistor test leads are approx. 11 mm and 7 mm after instal and solder.

Figure 98 N5451A ZIF Probe Head Dimensions with Long Wired ZIF Tip Attached

5 **Characteristics and Specifications**
Probe Dimensions

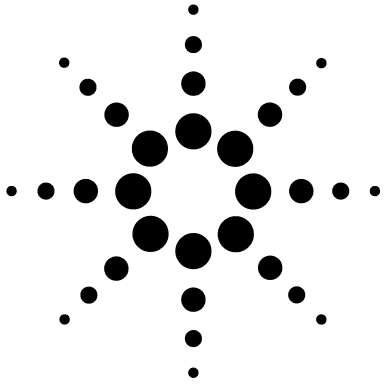

6

Performance Plots

N5380B SMA Probe Head (Full BW)	148
N5380B SMA Probe Head with the 1134A InfiniiMax Probe	151
N5381A & N5382A Differential Probe Heads (Full BW)	152
N5381A Differential Solder-in Probe Head with 2x Longer Wires	156
N5425A ZIF Probe Head (Full BW)	157
N5425A ZIF Probe Head with N5451A Long-Wired ZIF Tip	161
7 mm Leads with 0° Separation	162
7 mm Leads with 60° Separation	165
11 mm Leads with 0° Separation	169
11 mm Leads with 60° Separation	173
N5426A ZIF Probe Tip Impedance	176
E2675A Differential Browser	177
E2676A Single-Ended Browser	180
E2677A Differential Solder-in Probe Head (High BW)	183
E2678A Differential Socketed Probe Head (High BW)	186
E2678A Differential Socketed Probe Head w/ Damped Wire	189
E2679A Single-Ended Solder-In Probe Head (High BW)	192
N2887A/N2888A Soft Touch Probe Heads	194



N5380B SMA Probe Head (Full BW)

The following performance characteristic plots are for the 1168A and 1169A probes using N5380B probe head.

NOTE

Unless otherwise noted, time and frequency responses shown here are for the probe only. when the probe is used with the 90000 series oscilloscope, magnitude and phase correction is applied to further optimize the overall response.

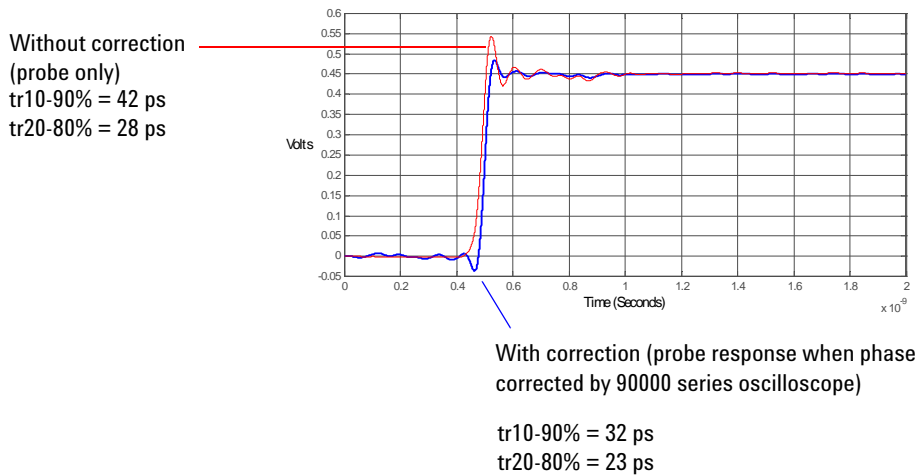

Figure 99 Step response with and without phase correction. Normalized to an ideal input step

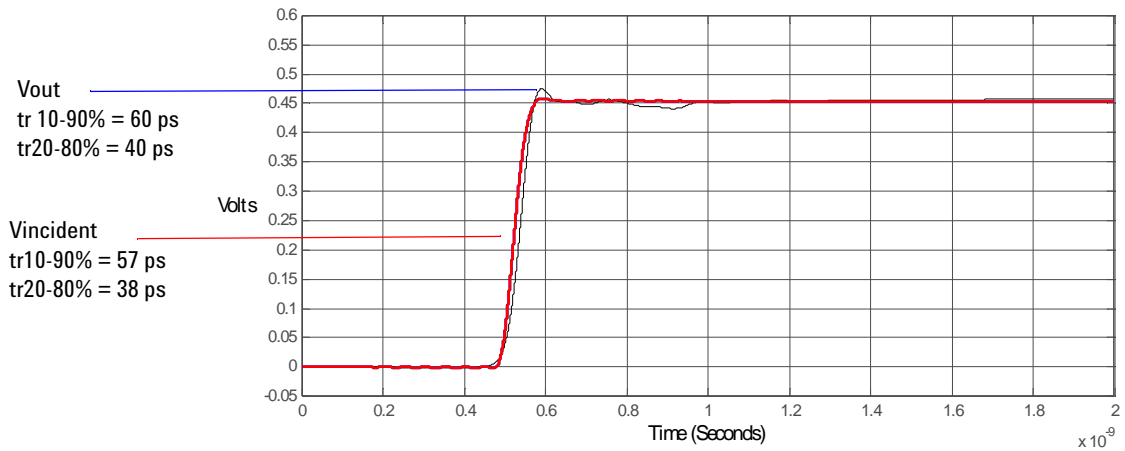

Figure 100 Vincident and Vout of probe with a 57 ps step

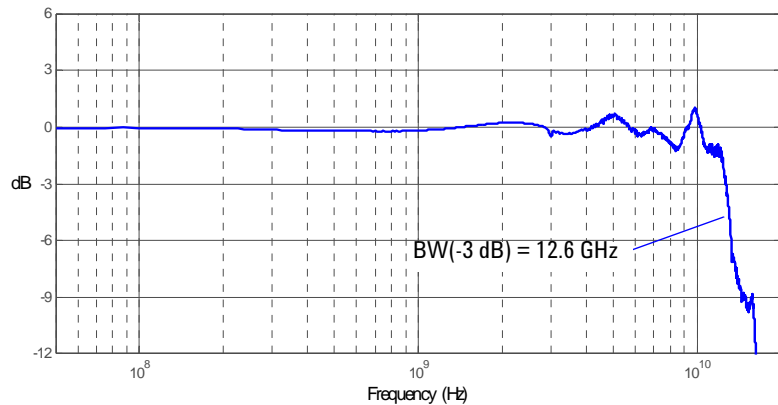

Figure 101 Magnitude plot of differential insertion loss +6.8 dB

6 Performance Plots
N5380B SMA Probe Head (Full BW)

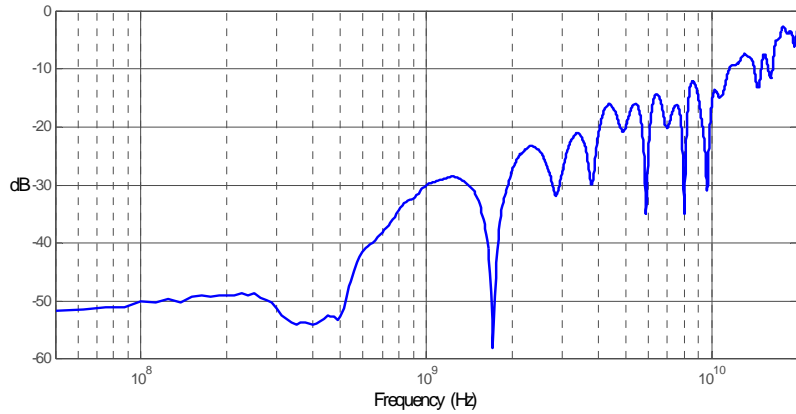

Figure 102 Magnitude plot of differential return loss

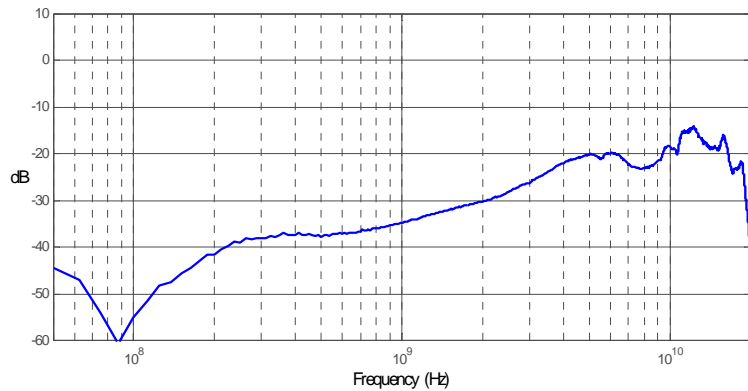

Figure 103 Magnitude plot of common mode response +6.8dB (common mode rejection)

N5380B SMA Probe Head with the 1134A InfiniiMax Probe

The following performance characteristic plots are for the 1134A probe using N5380B probe head.

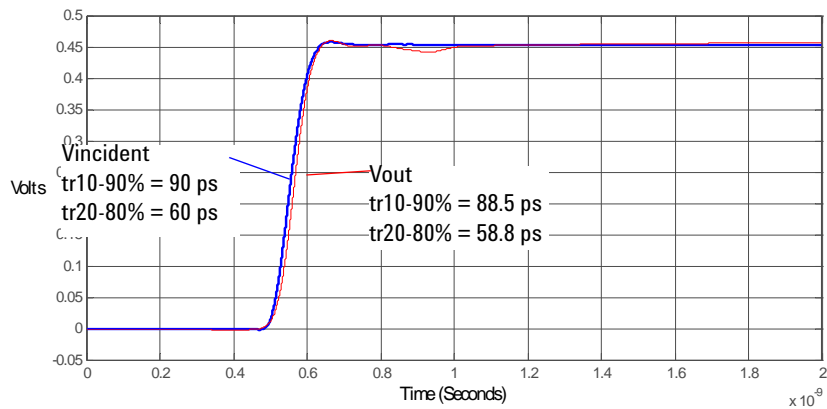

Figure 104 $V_{incident}$ and V_{out} of probe with a 90 ps step

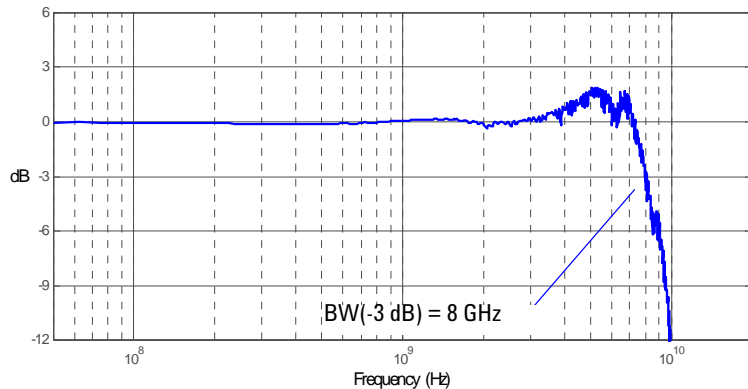

Figure 105 Magnitude response of differential insertion loss +16.03 dB

N5381A & N5382A Differential Probe Heads (Full BW)

The following performance characteristic plots are for the 1168A and 1169A probes using N5381A and N5382A probe heads.

NOTE

Unless otherwise noted, time and frequency responses shown here are for the probe only. When the probe is used with the 90000 series oscilloscope, magnitude and phase correction can be applied to further optimize the overall response.

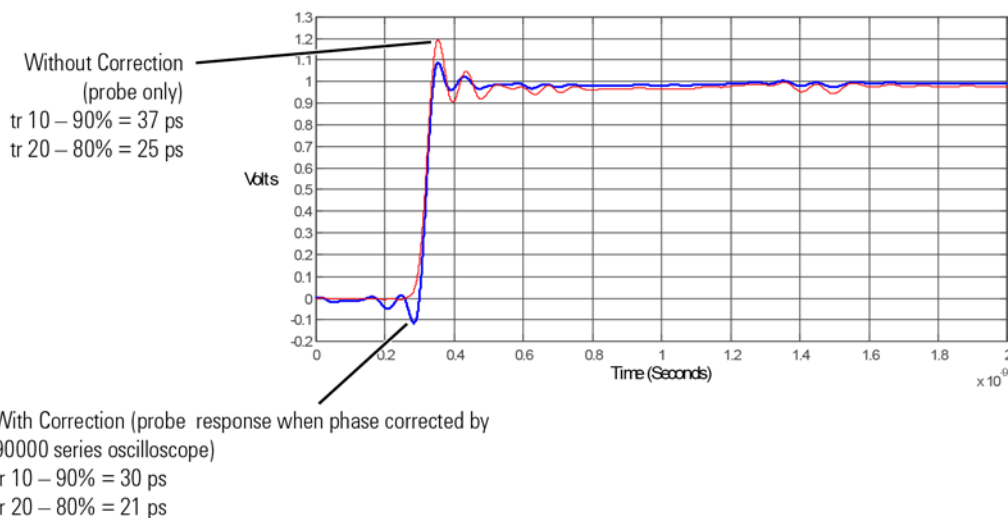

Figure 106 Step Response With and Without Phase Correction. Normalized to an Ideal Input Step

N5381A & N5382A Differential Probe Heads (Full BW)

Vsource
 tr10-90% = 58 ps
 tr20-80% = 37 ps

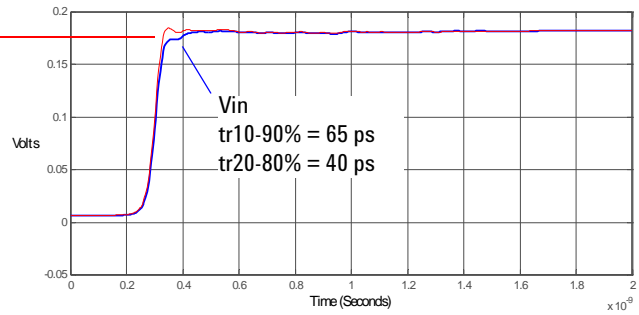

Figure 107 25Ω 58 ps step generator with and without probe connected

Vout
 tr 10-90% = 67 ps
 tr20-80% = 44 ps

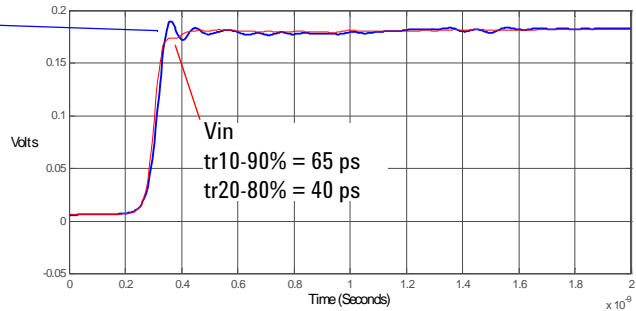

Figure 108 Vin and Vout of probe with a 25Ω 58 ps step generator

6 Performance Plots

N5381A & N5382A Differential Probe Heads (Full BW)

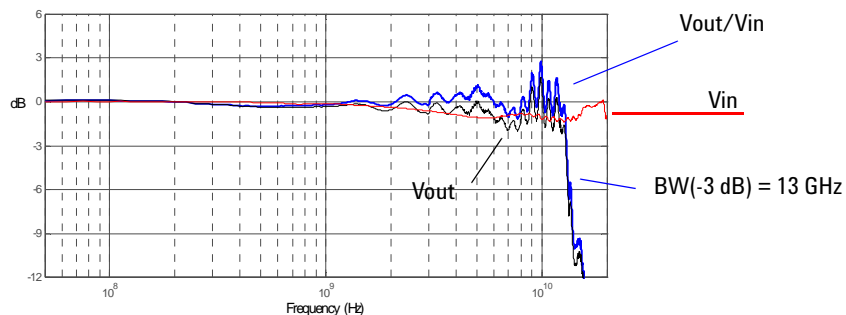

Figure 109 $\text{dB}(V_{in})$ and $\text{dB}(V_{out}) + 10.8\text{ dB}$ of probe with a 25Ω source and $\text{dB}(V_{out}/V_{in}) + 10.8\text{ dB}$ frequency response

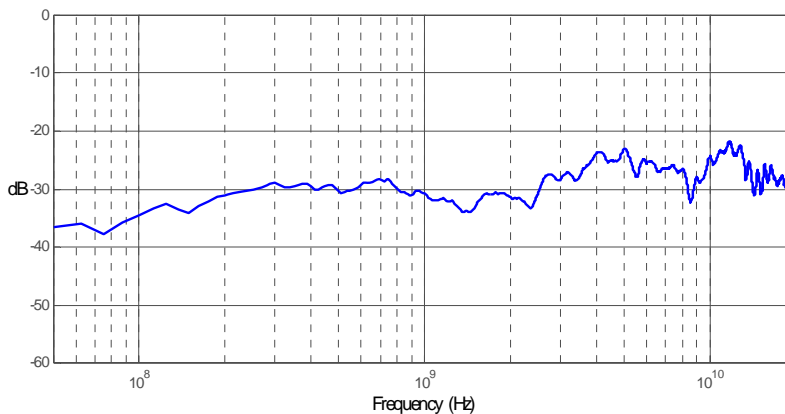

Figure 110 $\text{dB}(V_{out}/V_{in}) + 10.8\text{ dB}$ frequency response when inputs driven in common (common mode rejection)

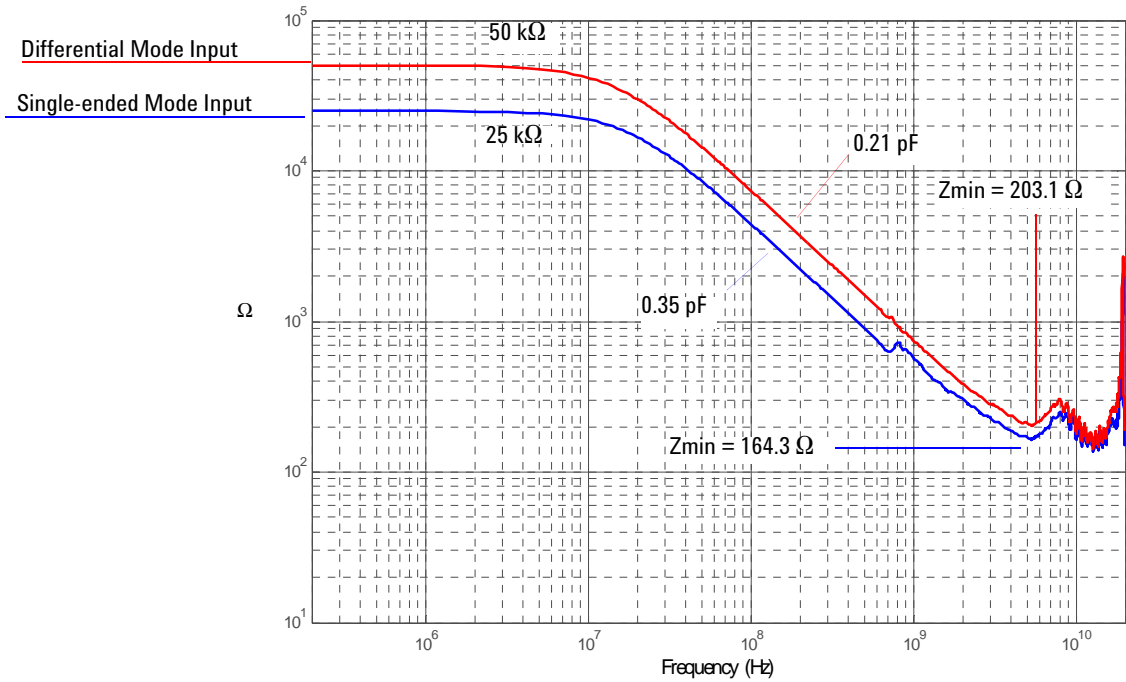

Figure 111 Magnitude plot of probe input impedance versus frequency

N5381A Differential Solder-in Probe Head with 2x Longer Wires

The following performance characteristic plots are for the 1169A probe using N5381A probe head. The plot shows the probe response to a 25 V, 58 ps step generator with the recommended wire length, twice the recommended wire length with wires parallel to each other, and twice the recommended wire length with wires spread 90 degrees.

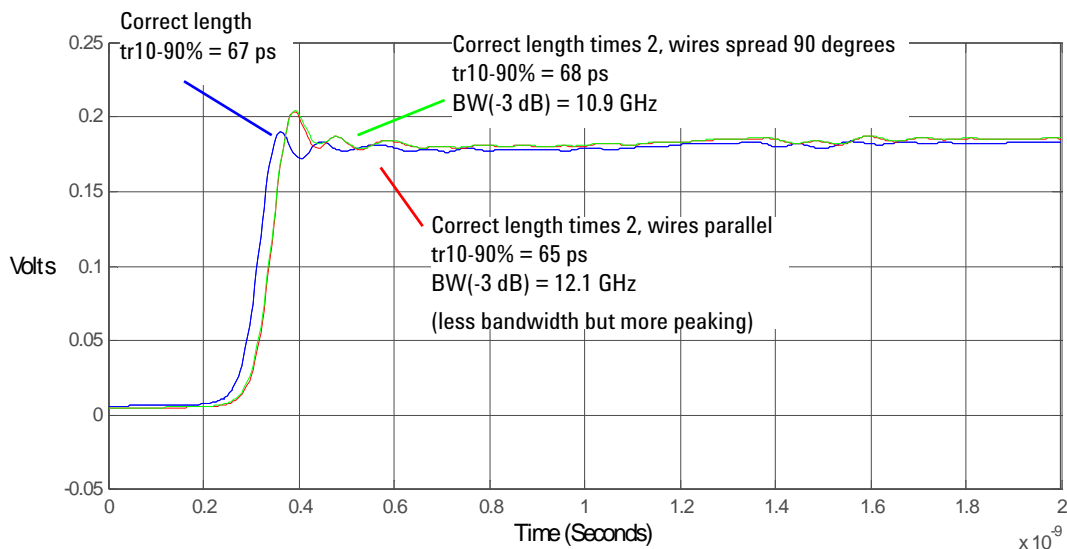

Figure 112 Probe Response

N5425A ZIF Probe Head (Full BW)

The following performance characteristic plots are for the 1168A and 1169A probes using N5425A probe head.

NOTE Unless otherwise noted, time and frequency responses shown here are for the probe only. when the probe is used with the 90000 series oscilloscope, magnitude and phase correction is applied to further optimize the overall response.

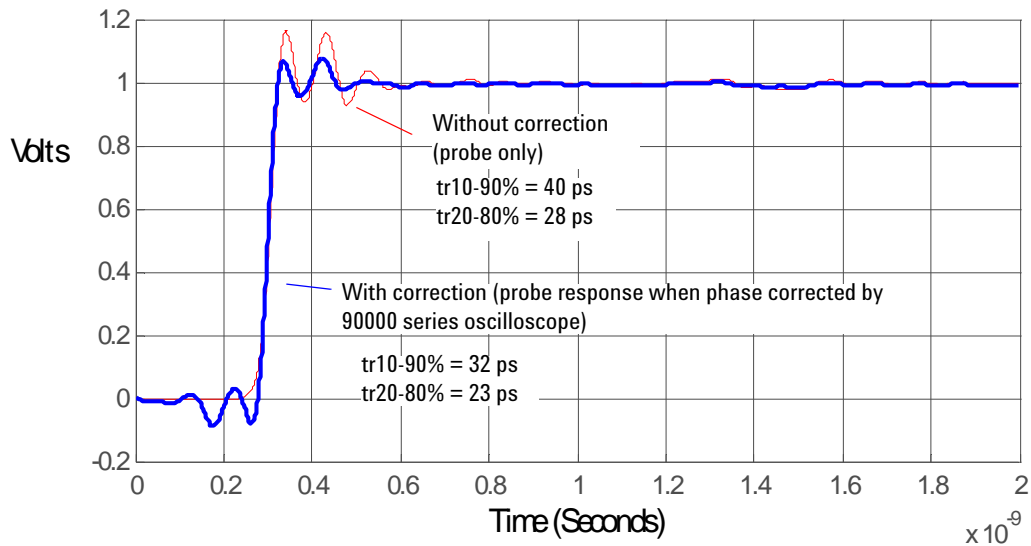

Figure 113 Step response with and without phase correction. Normalized to an ideal input step

6 Performance Plots
N5425A ZIF Probe Head (Full BW)

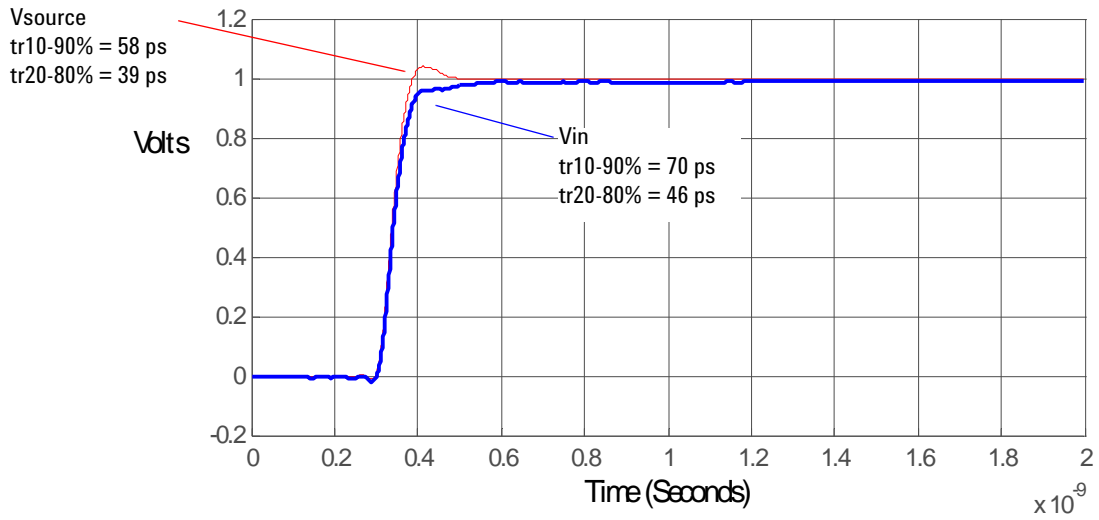

Figure 114 25Ω 58 ps step with and without the probe connected

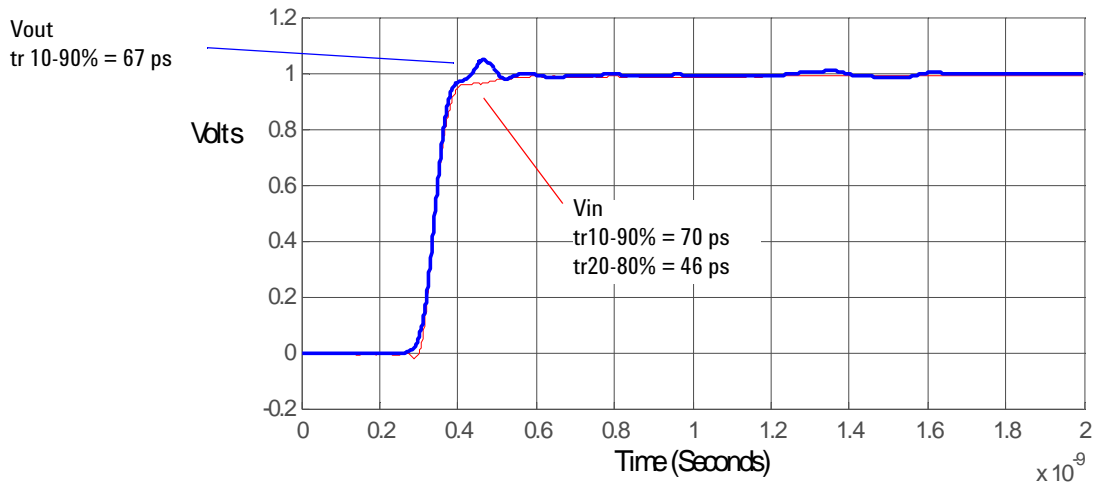

Figure 115 Vin and Vout of probe with a 25Ω 58 ps step

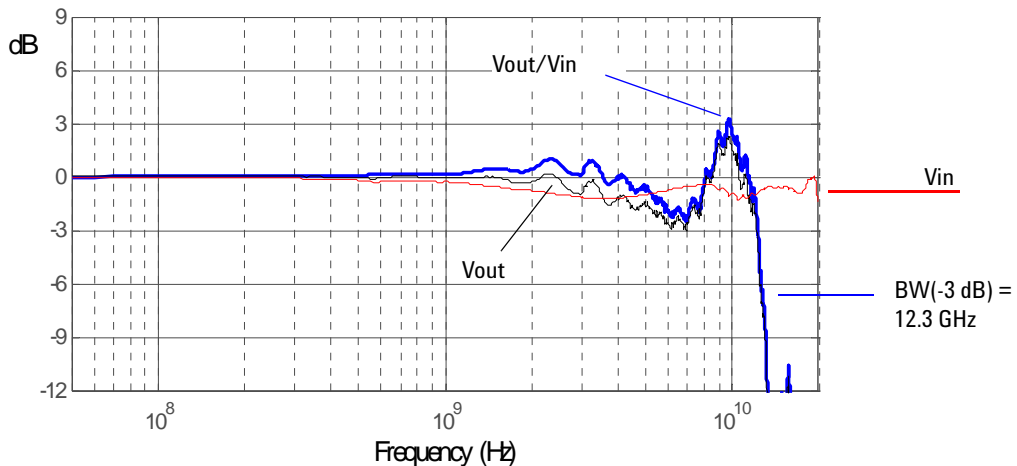

Figure 116 $\text{dB}(V_{in})$ and $\text{dB}(V_{out}) + 10.8 \text{ dB}$ of probe with a 25Ω source and $\text{dB}(V_{out}/V_{in}) + 10.8 \text{ dB}$ frequency response

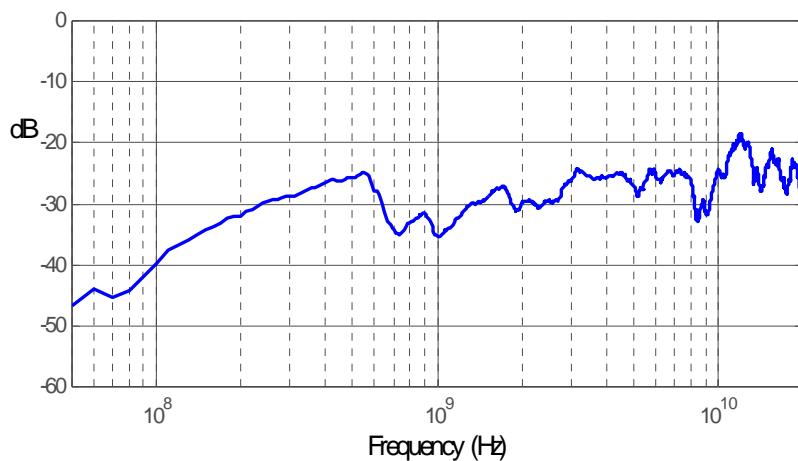

Figure 117 $\text{dB}(V_{out}/V_{in}) + 10.8 \text{ dB}$ frequency response when inputs driven in common (common mode rejection)

6 Performance Plots
N5425A ZIF Probe Head (Full BW)

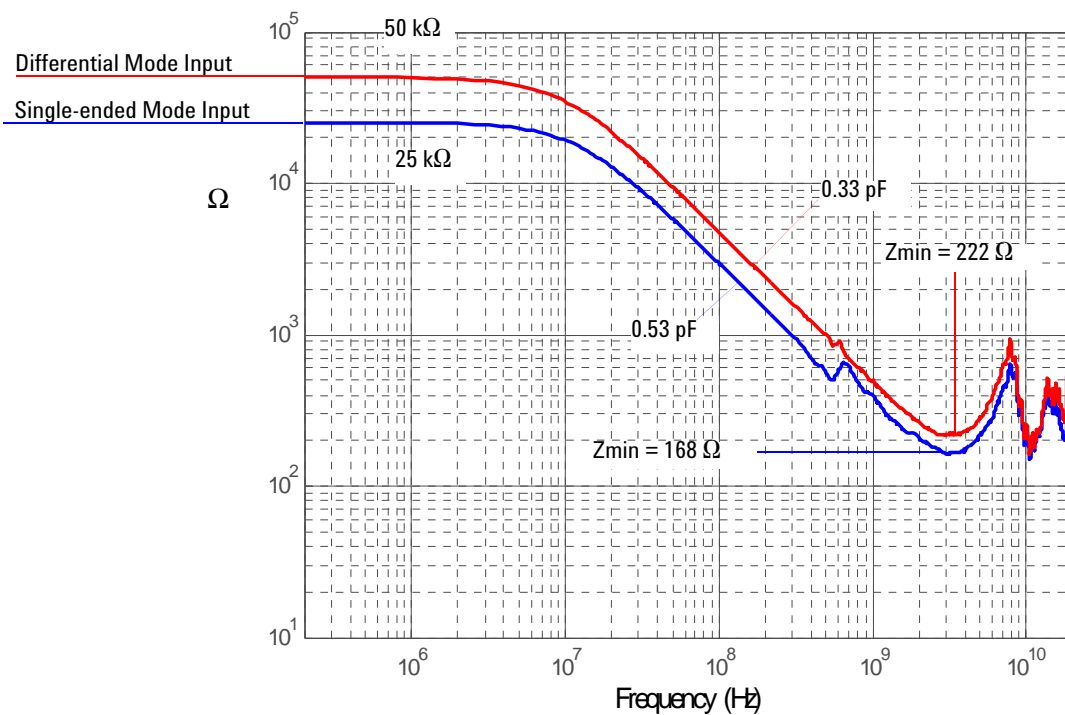

Figure 118 Magnitude plot of probe input impedance versus frequency

N5425A ZIF Probe Head with N5451A Long-Wired ZIF Tip

The following performance characteristic plots are for the 1168A and 1169A probes using the N5451A ZIF tip. The plots are organized according to tip's lead length and separation between leads.

NOTE

Unless otherwise noted, time and frequency responses shown here are for the probe only. When the probe is used with the 90000 series oscilloscope, magnitude and phase correction is applied to further optimize the overall response.

7 mm Leads with 0° Separation

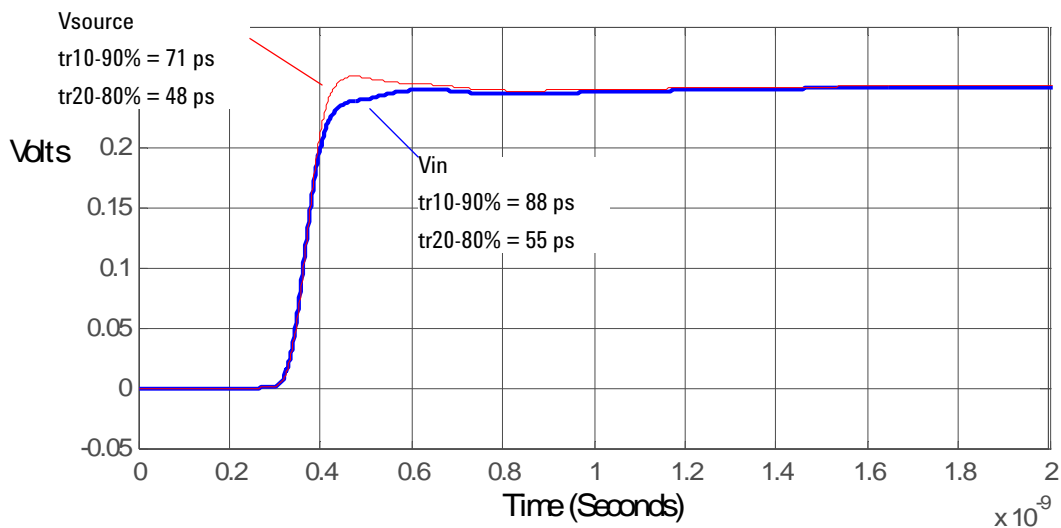

Figure 119 25Ω 71 ps step generator with and without the probe connected

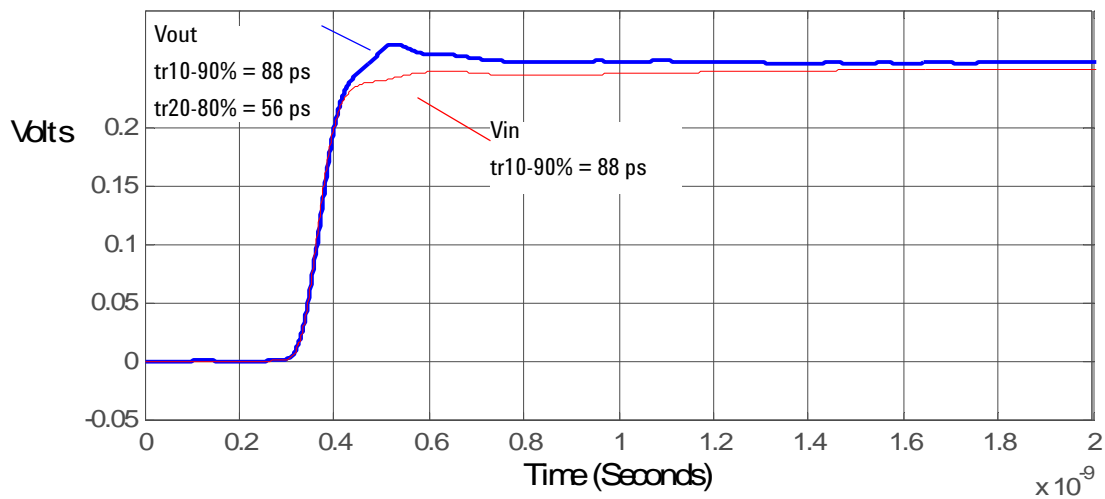

Figure 120 Vin and Vout of probe with a 25Ω 71 ps step generator

N5425A ZIF Probe Head with N5451A Long-Wired ZIF Tip

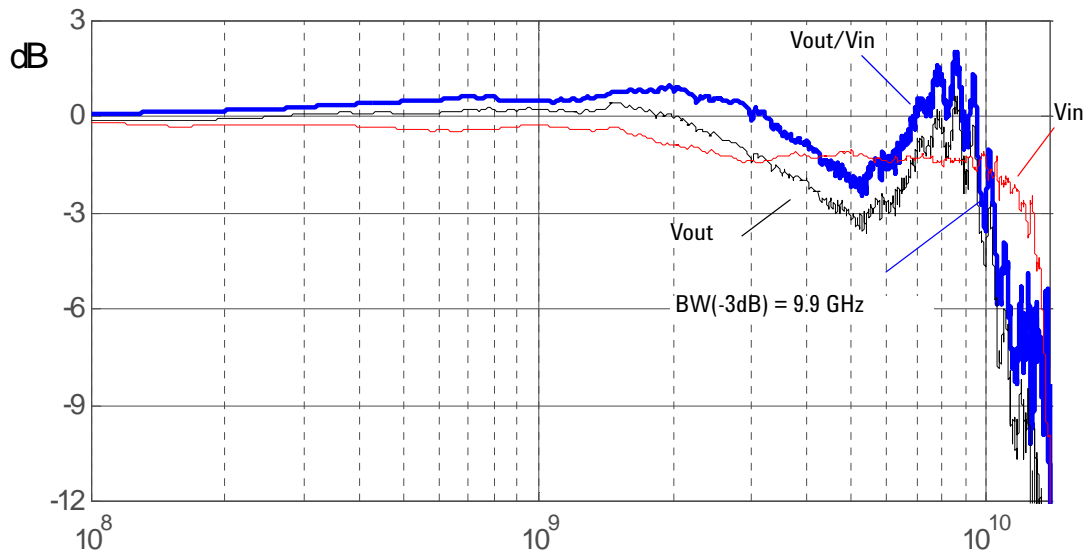

Figure 121 $\text{dB}(V_{in})$ and $\text{dB}(V_{out}) + 10.8 \text{ dB}$ of probe with a 25Ω source and $\text{dB}(V_{out}/V_{in}) + 10.8 \text{ dB}$ frequency response

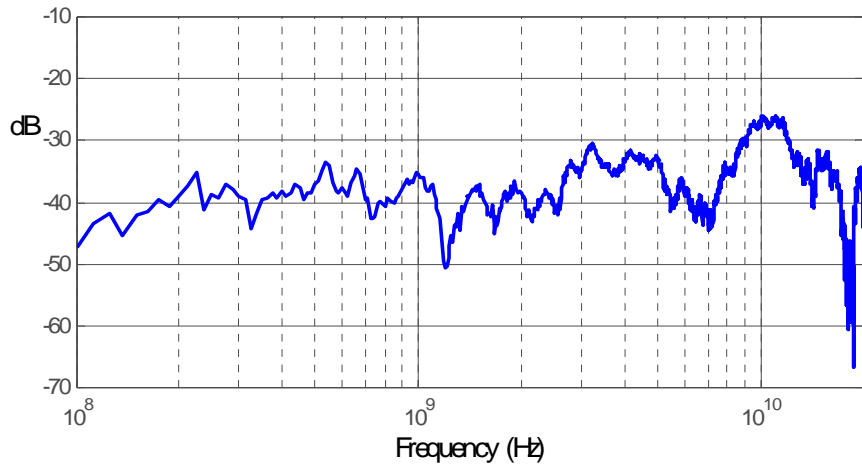

Figure 122 $\text{dB}(V_{out}/V_{in}) + 10.8 \text{ dB}$ frequency response when inputs driven in common (common mode rejection)

6 Performance Plots
N5425A ZIF Probe Head with N5451A Long-Wired ZIF Tip

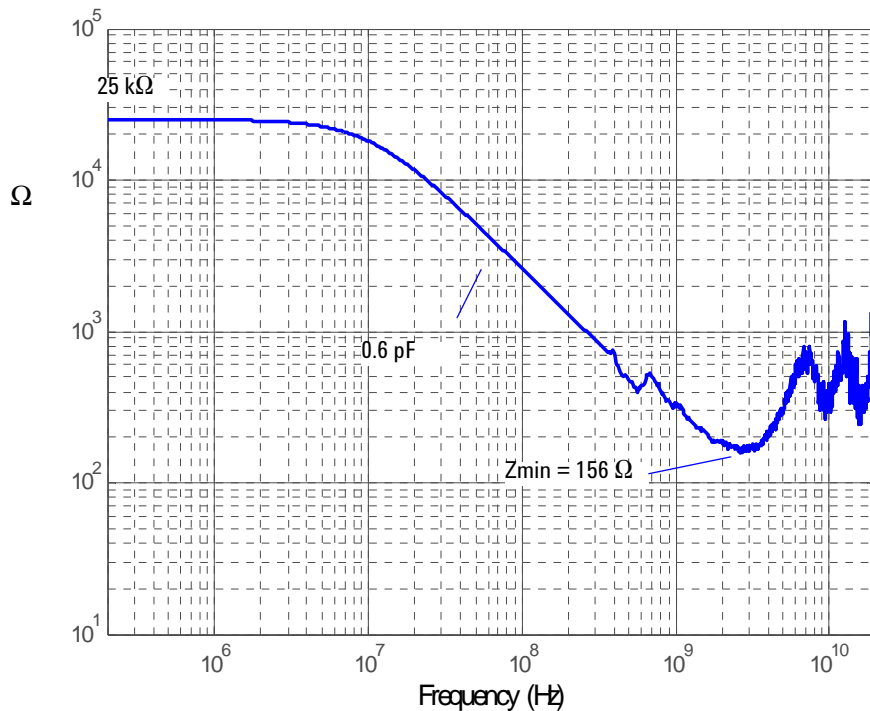

Figure 123 Magnitude plot of probe input impedance versus frequency (single ended mode input)

7 mm Leads with 60° Separation

The following graphs are for 7 mm long leads with 60° separation between the resistor leads.

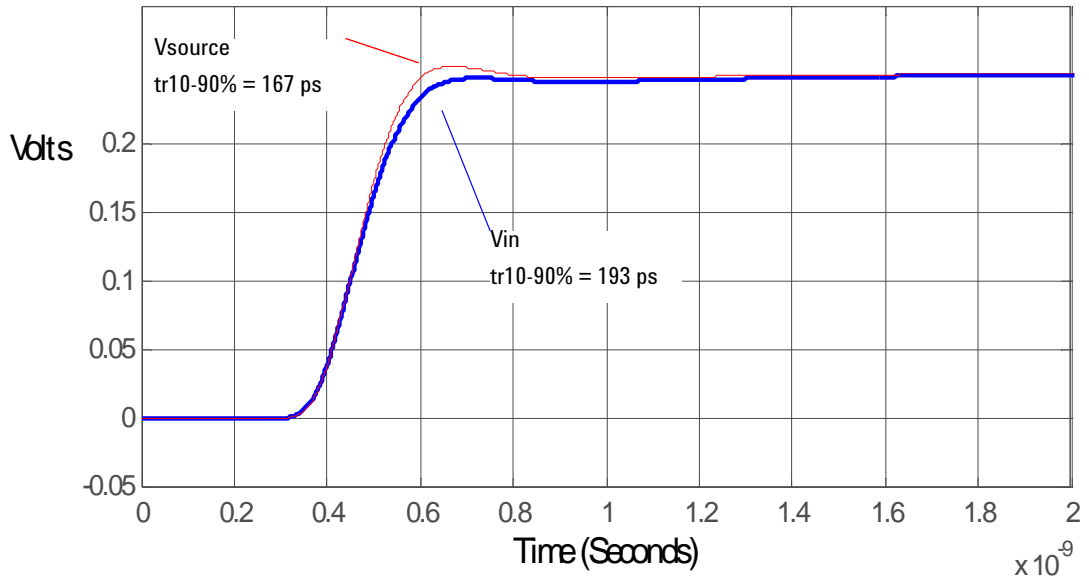

Figure 124 25Ω 167 ps step generator with and without the probe connected

6 Performance Plots
N5425A ZIF Probe Head with N5451A Long-Wired ZIF Tip

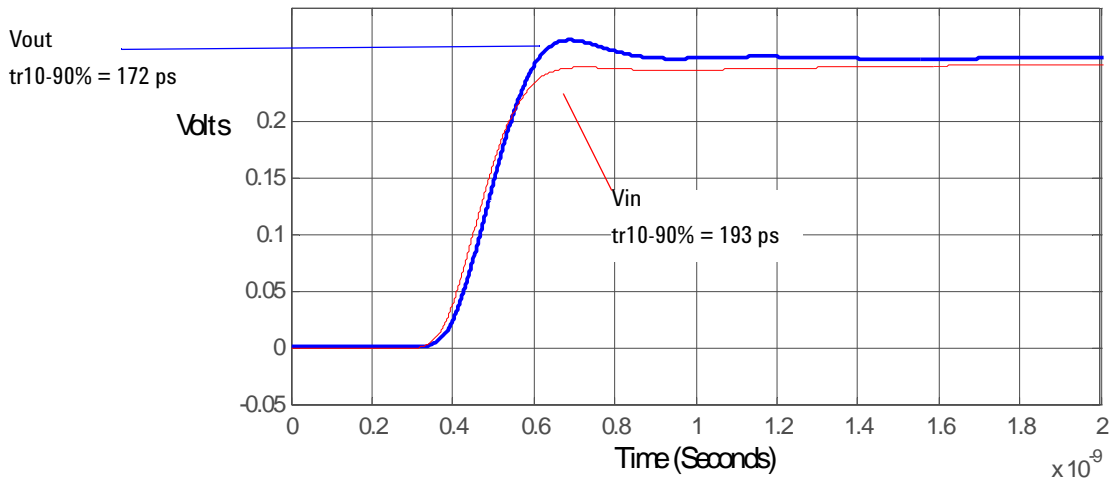

Figure 125 Vout and Vin of probe with a 25Ω 167 ps step generator

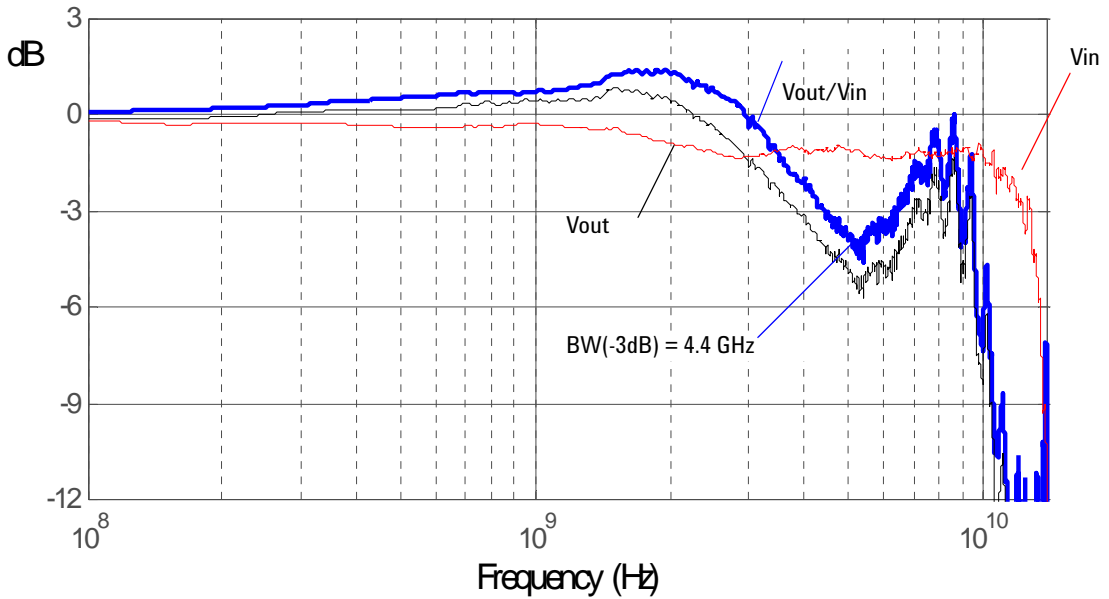

Figure 126 dB(Vin) and dB(Vout) + 10.8 dB of probe with a 25Ω source and dB(Vout/Vin) + 10.8 dB frequency response

N5425A ZIF Probe Head with N5451A Long-Wired ZIF Tip

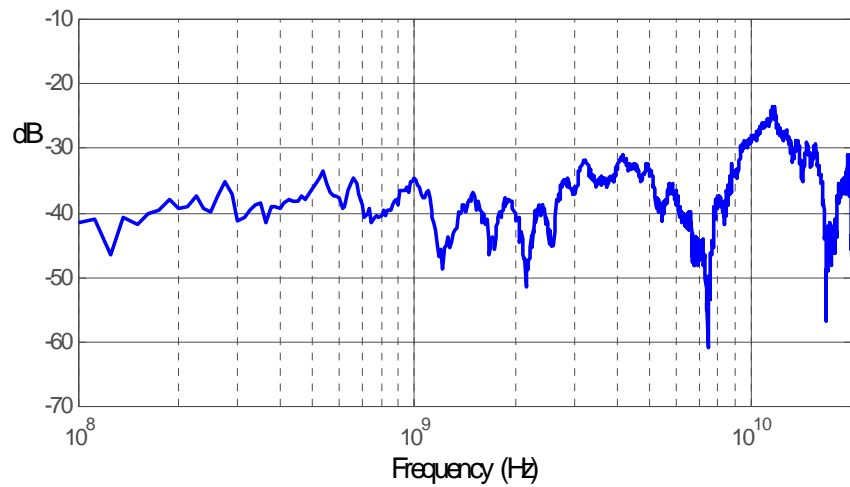

Figure 127 $\text{dB}(V_{\text{out}}/V_{\text{in}}) + 10.8 \text{ dB}$ frequency response when inputs driven in common (common mode rejection).

6 Performance Plots
N5425A ZIF Probe Head with N5451A Long-Wired ZIF Tip

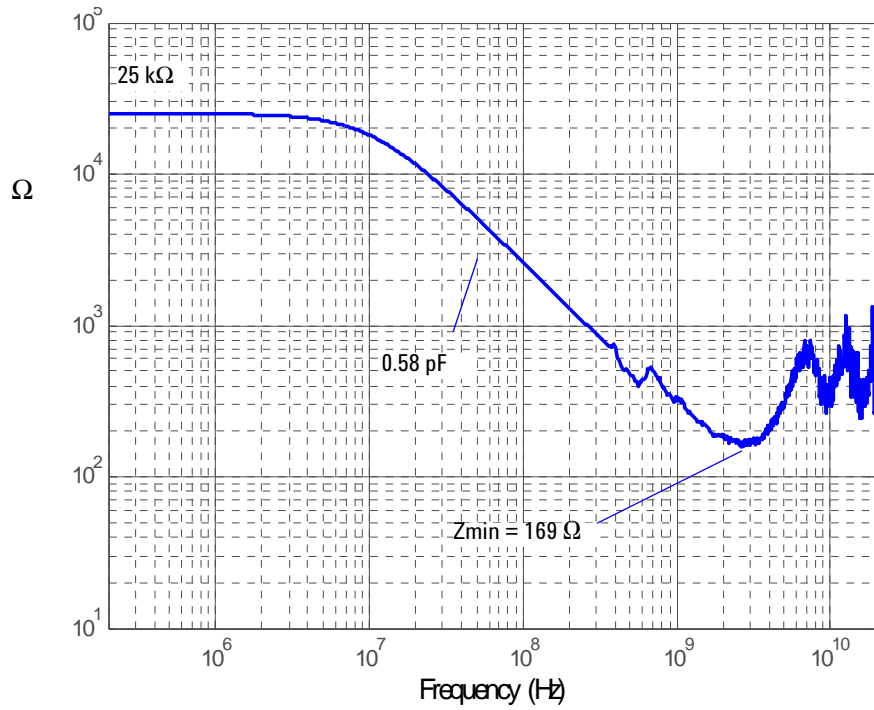

Figure 128 Magnitude plot of probe input impedance versus frequency (single-ended mode input)

11 mm Leads with 0° Separation

The following graphs are for 11 mm long leads with 0° separation between the resistor leads.

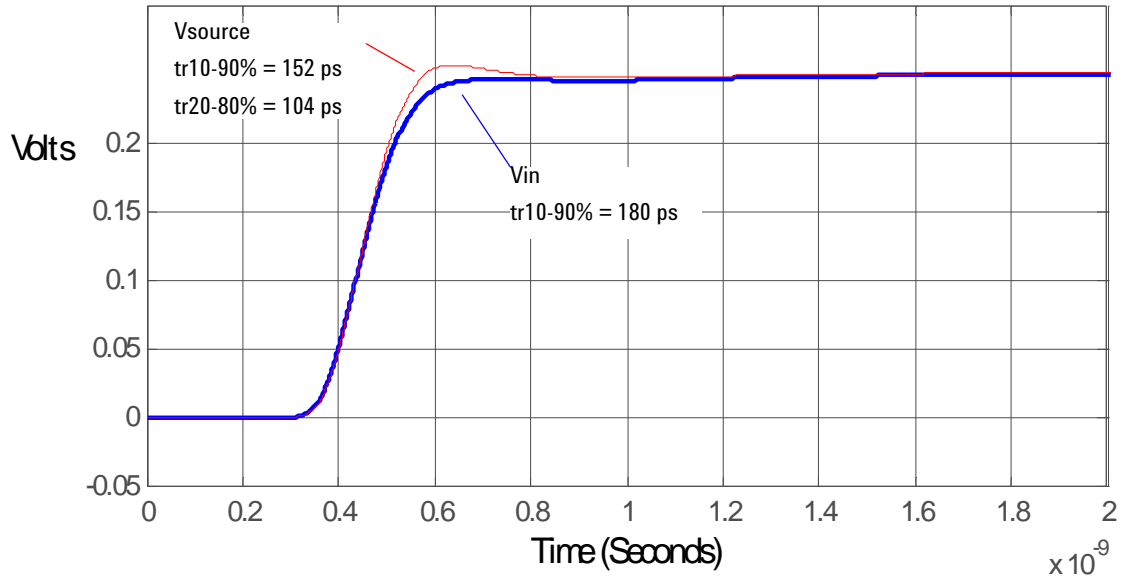

Figure 129 25 Ω 152 ps step generator with and without the probe connected

6 Performance Plots
N5425A ZIF Probe Head with N5451A Long-Wired ZIF Tip

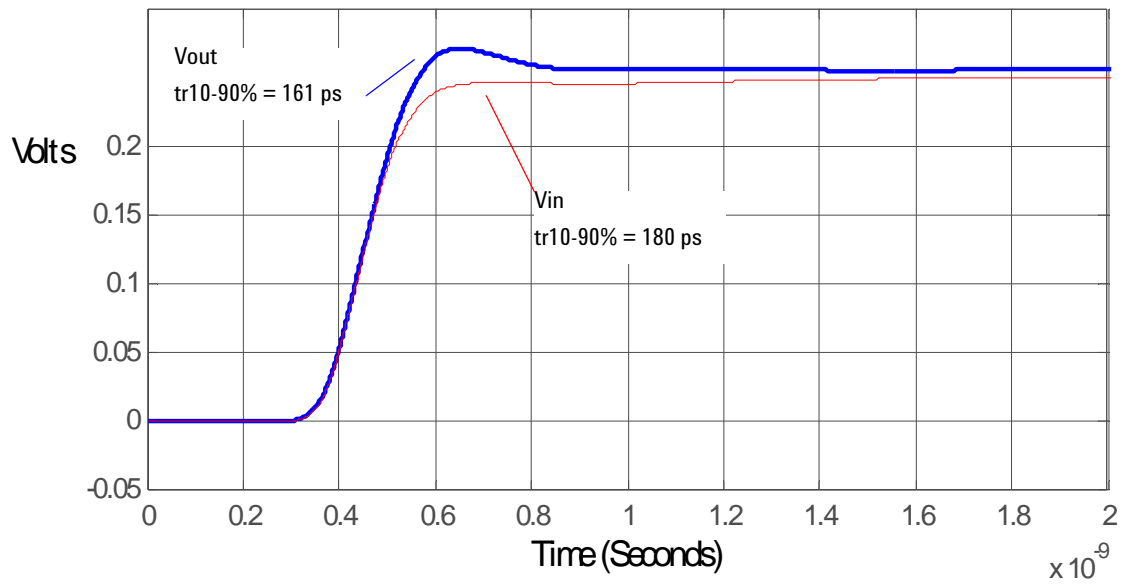

Figure 130 Vin and Vout of probe with a 25Ω 152 ps step generator

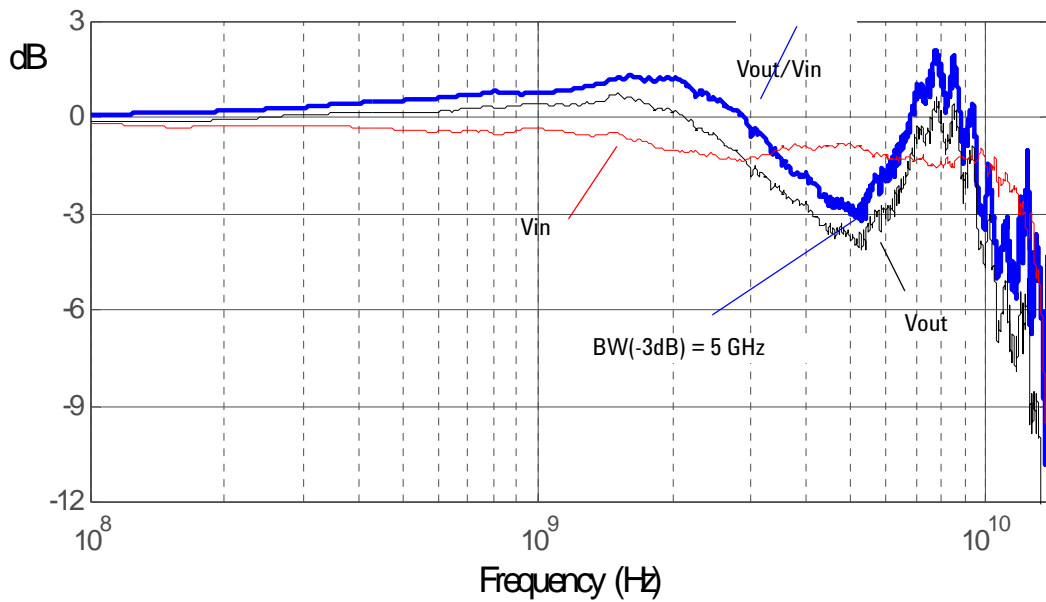

Figure 131 $\text{dB}(V_{in})$ and $\text{dB}(V_{out}) + 10.8 \text{ dB}$ of probe with a 25Ω source and $\text{dB}(V_{out}/V_{in}) + 10.8 \text{ dB}$ frequency response

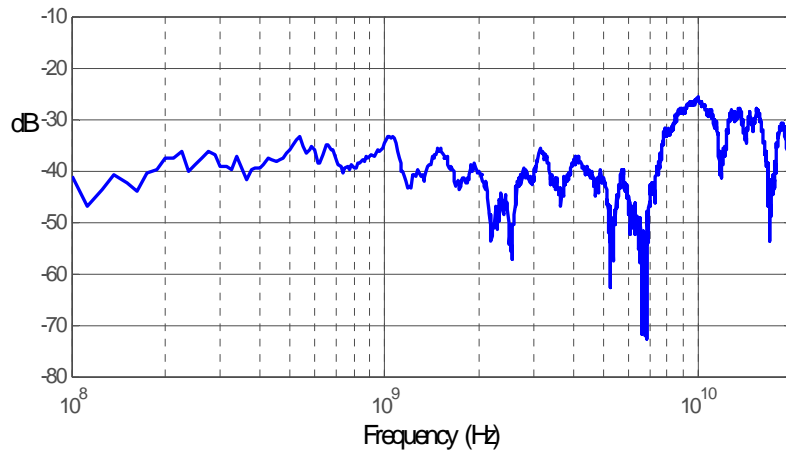

Figure 132 $\text{dB}(V_{out}/V_{in}) + 10.8 \text{ dB}$ frequency response when inputs driven in common (common mode rejection)

6 Performance Plots
N5425A ZIF Probe Head with N5451A Long-Wired ZIF Tip

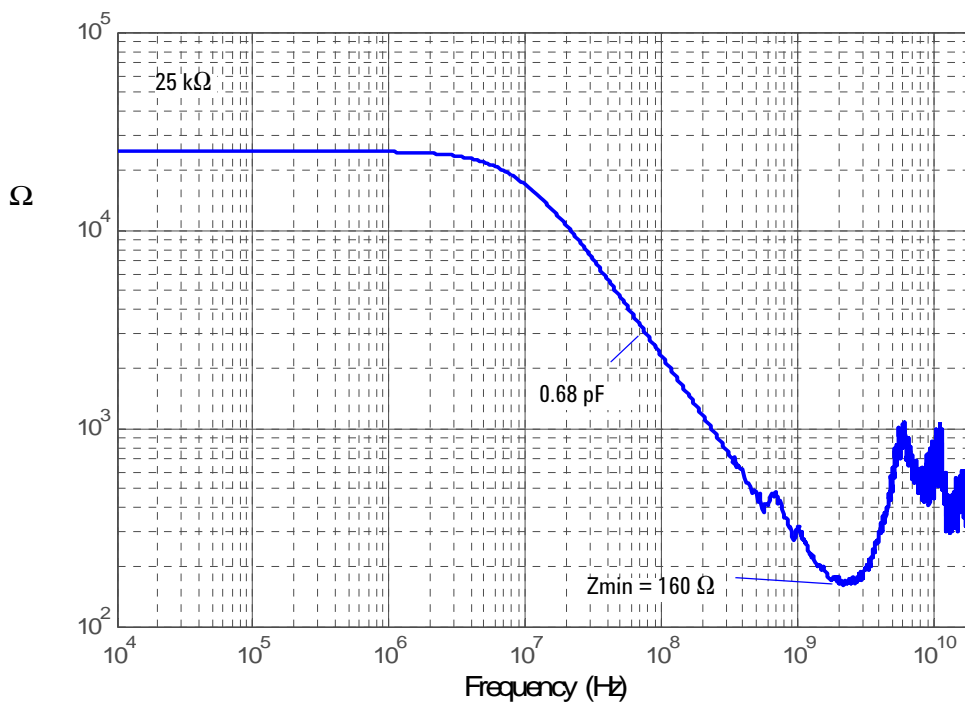

Figure 133 Magnitude plot of probe input impedance versus frequency (single-ended mode input)

11 mm Leads with 60° Separation

The following graphs are for 11 mm long leads with 60° separation between the resistor leads.

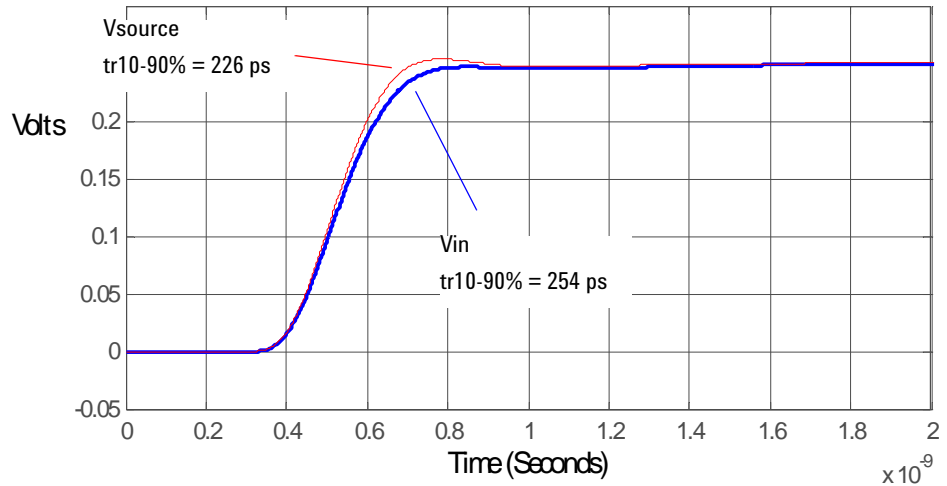

Figure 134 25 Ω 226 ps step generator with and without the probe connected

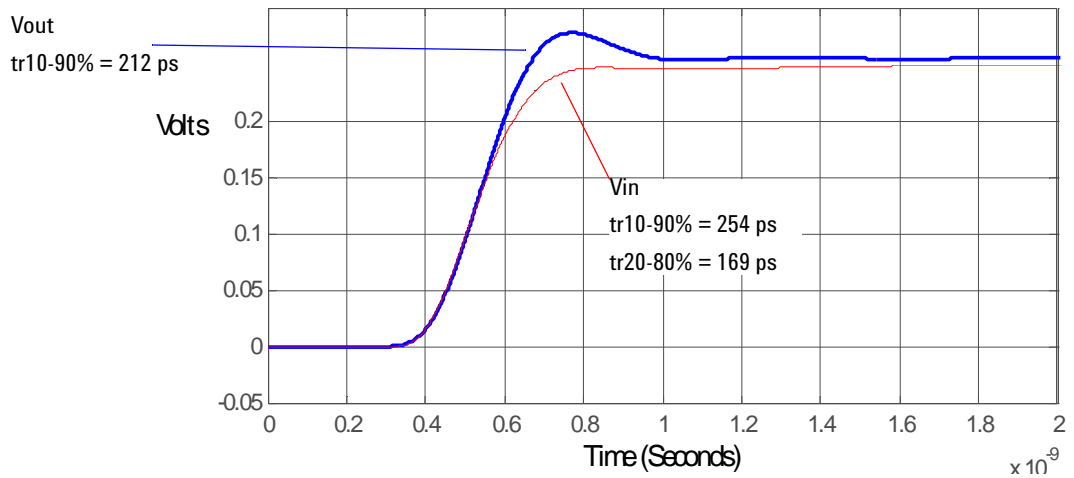

Figure 135 V_{in} and V_{out} of probe with a 25 Ω 226 ps step generator

6 Performance Plots
N5425A ZIF Probe Head with N5451A Long-Wired ZIF Tip

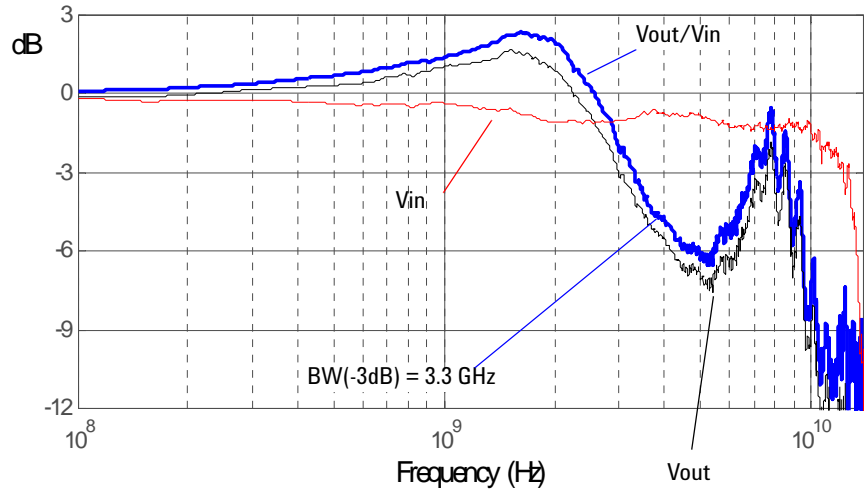

Figure 136 $\text{dB}(V_{in})$ and $\text{dB}(V_{out}) + 10.8 \text{ dB}$ of probe with a 25Ω source and $\text{dB}(V_{out}/V_{in}) + 10.8 \text{ dB}$ frequency response

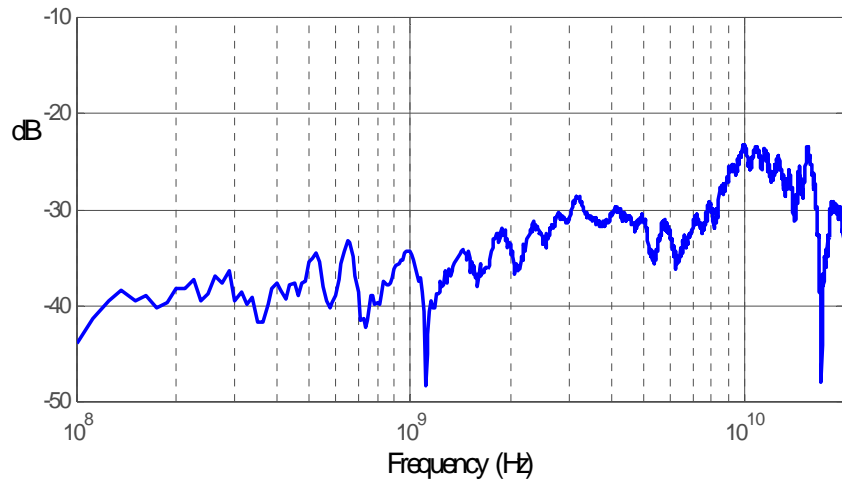

Figure 137 $\text{dB}(V_{out}/V_{in}) + 10.8 \text{ dB}$ frequency response when inputs driven in common (common mode rejection)

N5425A ZIF Probe Head with N5451A Long-Wired ZIF Tip

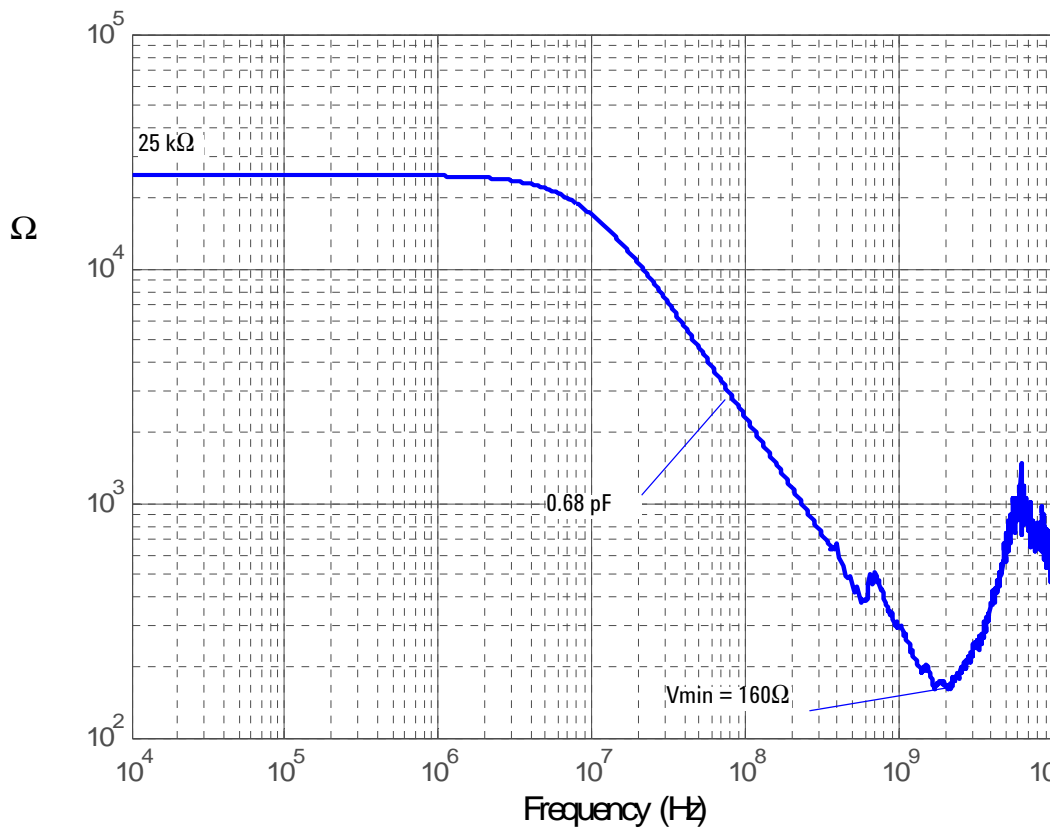

Figure 138 Magnitude plot of probe input impedance versus frequency (single-ended mode input)

N5426A ZIF Probe Tip Impedance

The impedance plot shown in Figure 139 is of the ZIF probe tip without the probe head connected.

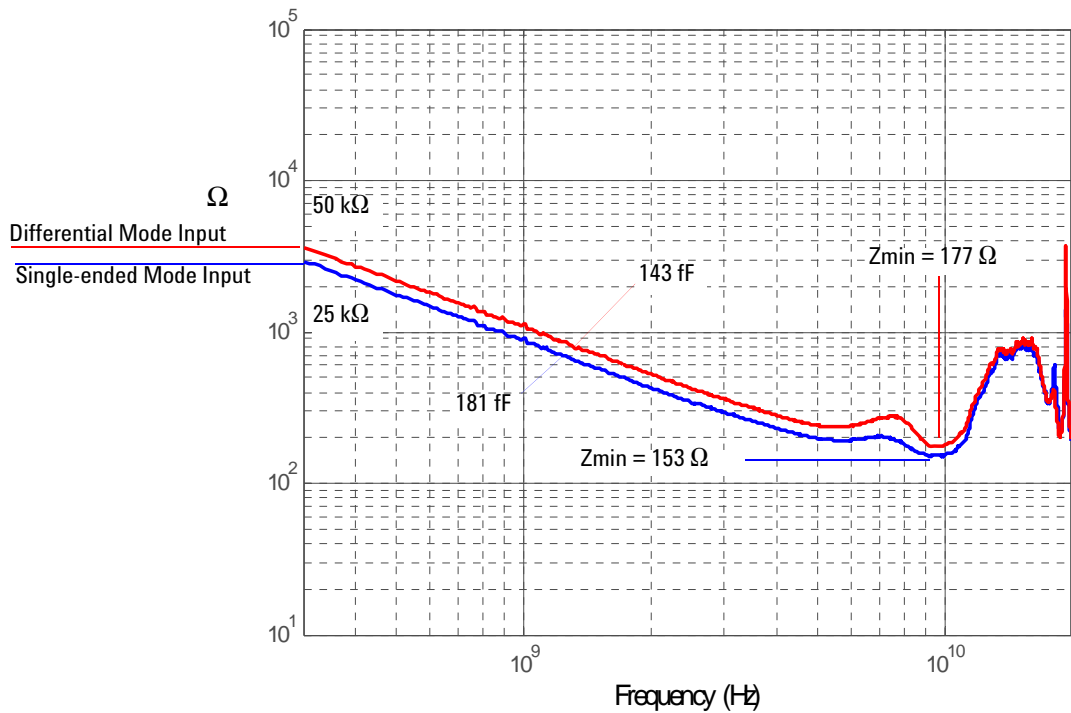

Figure 139 Magnitude plot of accessory input impedance versus frequency.

E2675A Differential Browser

The following performance characteristic plots are for the 1169A probe using E2675A probe head.

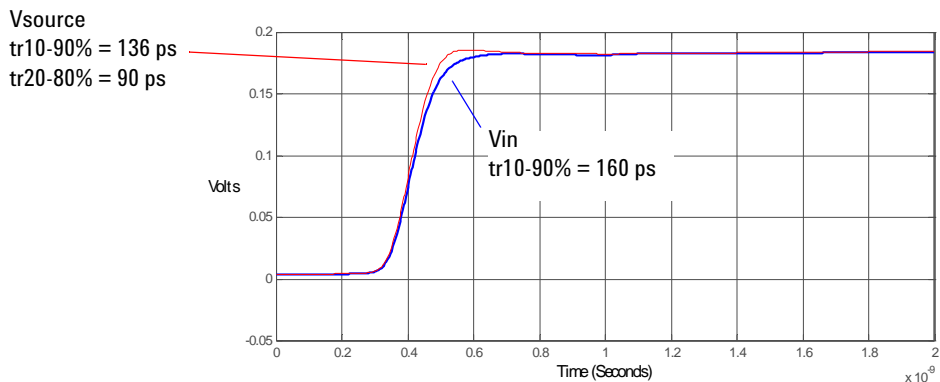

Figure 140 25Ω 136 ps step generator with and without probe connected

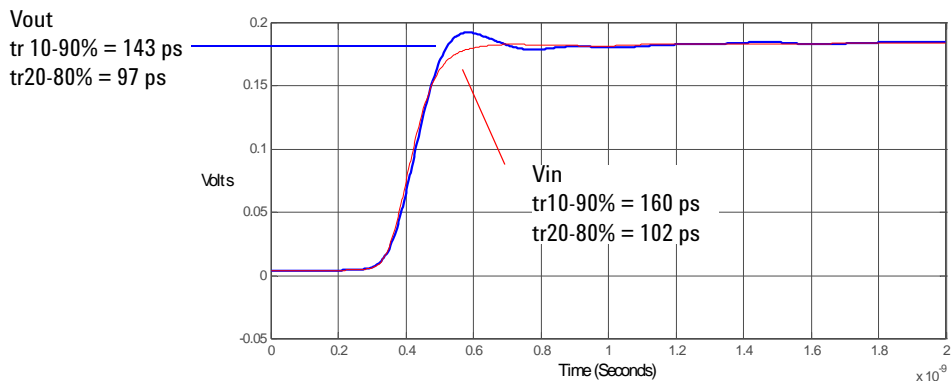

Figure 141 Vin and Vout of probe with a 25Ω 136 ps step generator

6 Performance Plots
E2675A Differential Browser

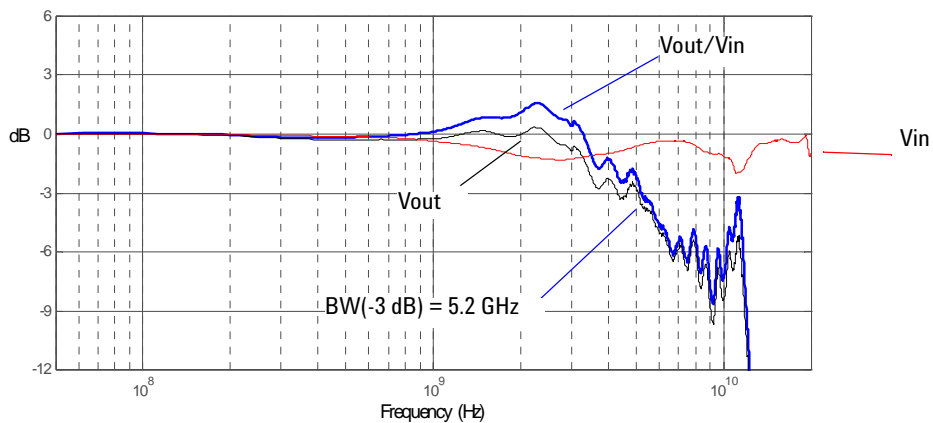

Figure 142 $\text{dB}(\text{Vin})$ and $\text{dB}(\text{Vout}) + 10.8 \text{ dB}$ of probe with a 25Ω source and $\text{dB}(\text{Vout}/\text{Vin}) + 10.8 \text{ dB}$ frequency response

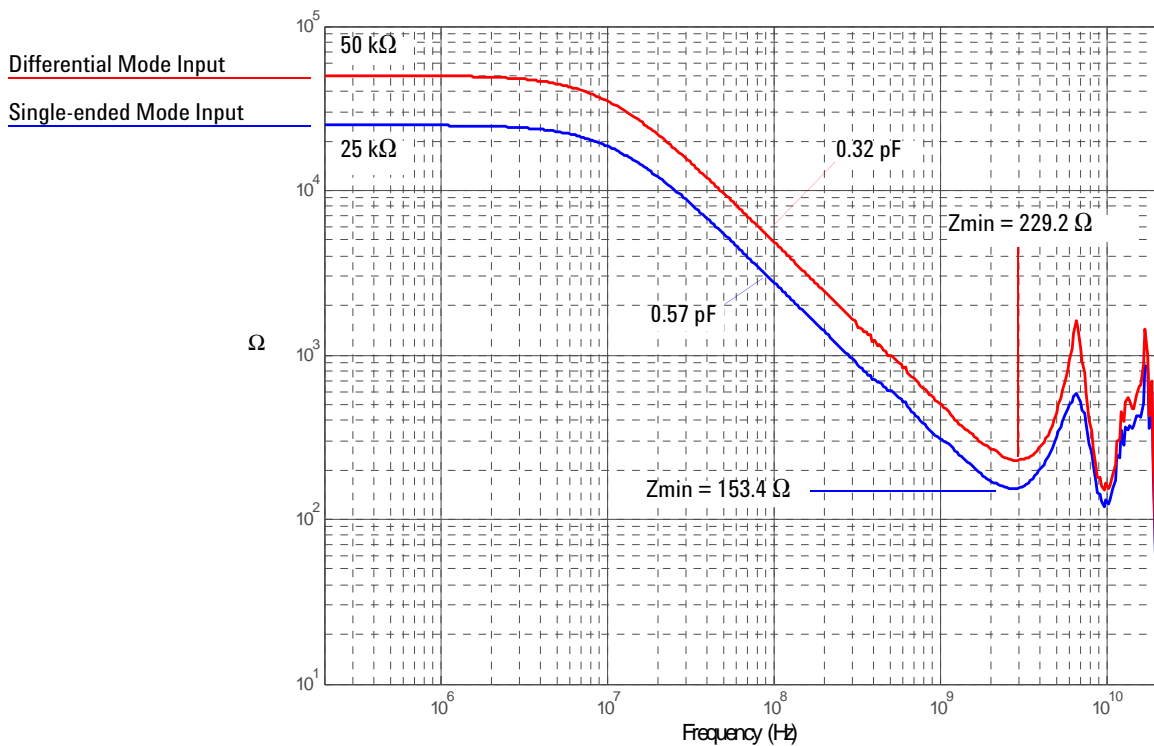

Figure 143 Magnitude plot of probe input impedance versus frequency

E2676A Single-Ended Browser

The following performance characteristic plots are for the 1169A probe using E2676A probe head.

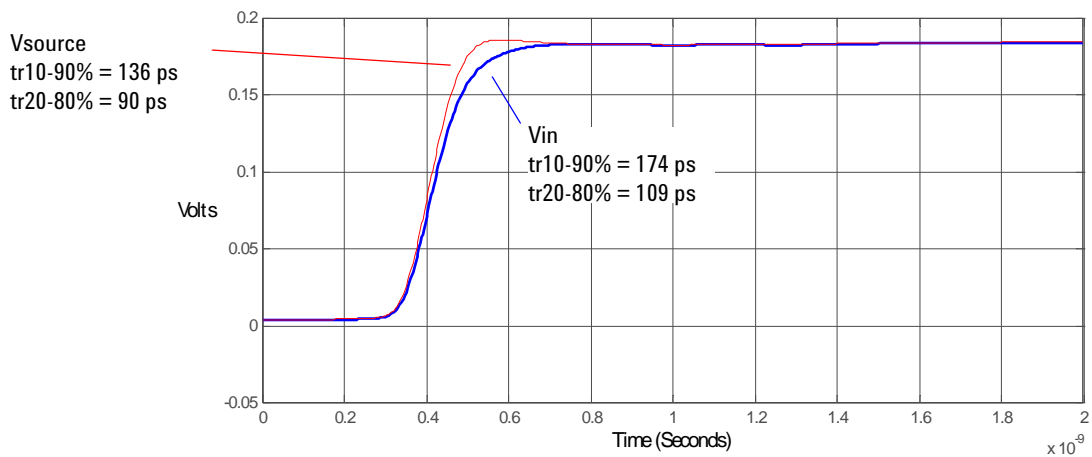

Figure 144 25 Ω 100 ps step generator with and without probe connected

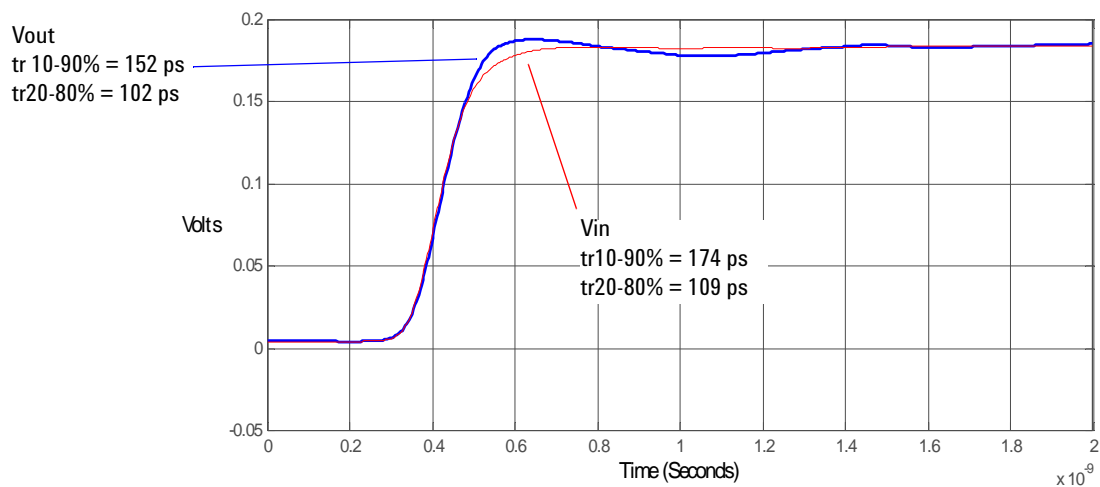

Figure 145 Vin and Vout of probe with a 25Ω 100 ps step generator

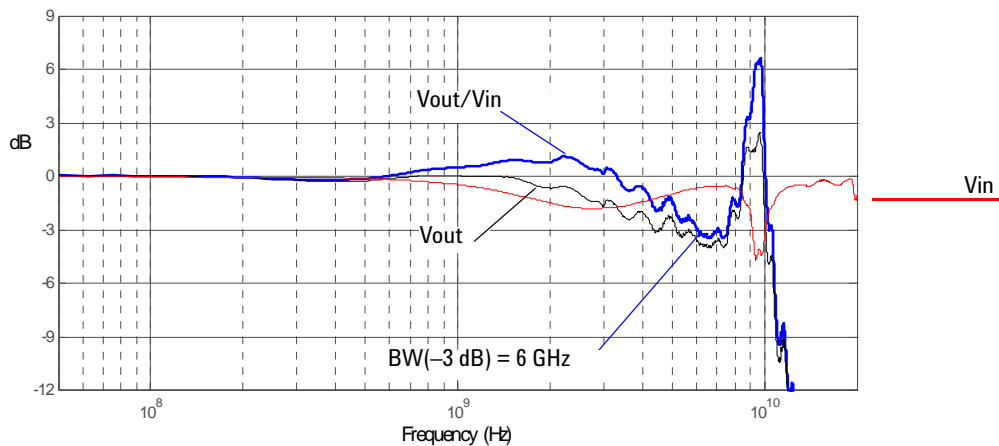

Figure 146 $\text{dB}(V_{in})$ and $\text{dB}(V_{out}) + 10.8 \text{ dB}$ of probe with a 25Ω source and $\text{dB}(V_{out}/V_{in}) + 10.8 \text{ dB}$ frequency response

6 Performance Plots

E2676A Single-Ended Browser

NOTE

The ground inductance and structure of the E2676A Single-ended Browser causes a resonant peak at ~10 GHz. This probe head was designed for the 1134A 7 GHz probe system. The input signal should be limited to an equivalent bandwidth of about 4.2 GHz (110 ps, 10 – 90%) to prevent ringing at 10 GHz.

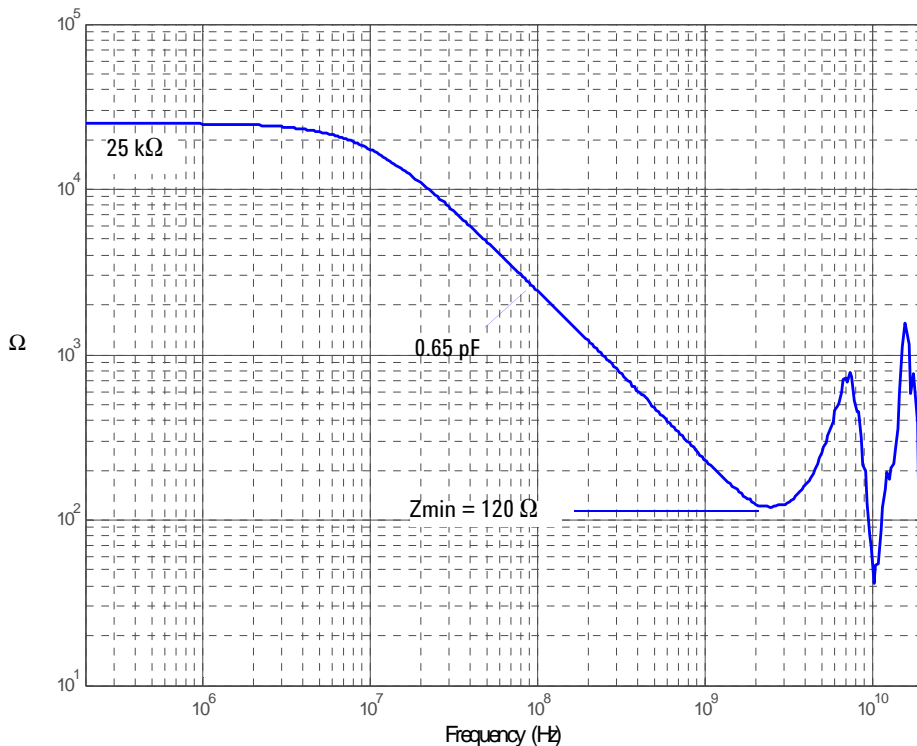

Figure 147 Magnitude plot of probe input impedance versus frequency

E2677A Differential Solder-in Probe Head (High BW)

The following performance characteristic plots are for the 1169A probe using E2677A probe head.

NOTE

For solder-in applications, the N5381A probe head is preferred. Variations in the manufacture and positioning of the mini-axial lead resistors used with the E2677A cause variations in the response. If you must use the E2677A, ensure that the mini-axial lead resistors are positioned directly adjacent to each other and touching.

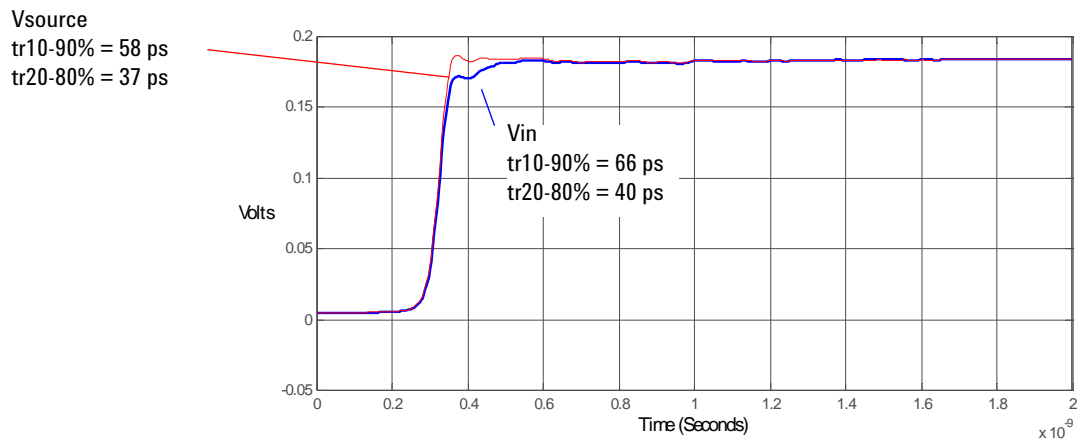

Figure 148 25Ω 58 ps step generator with and without probe connected

6 Performance Plots
E2677A Differential Solder-in Probe Head (High BW)

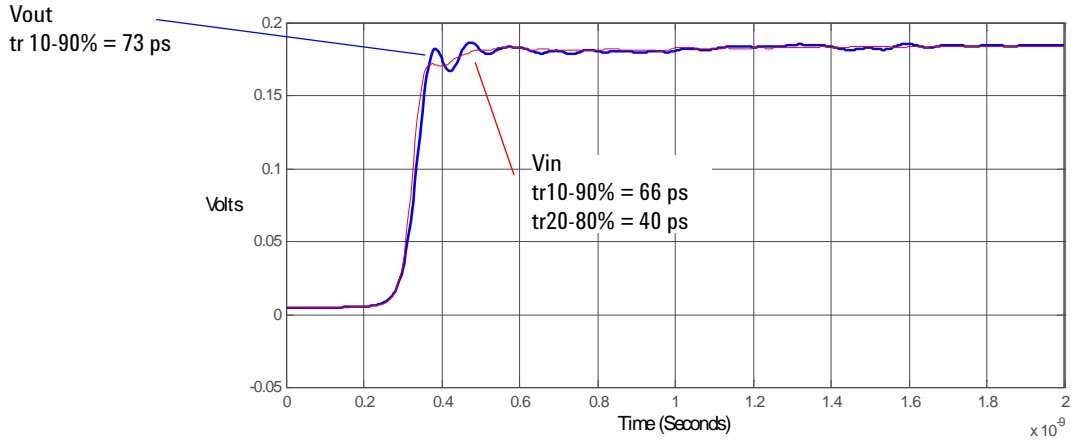

Figure 149 Vin and Vout of probe with a 25Ω 58 ps step generator

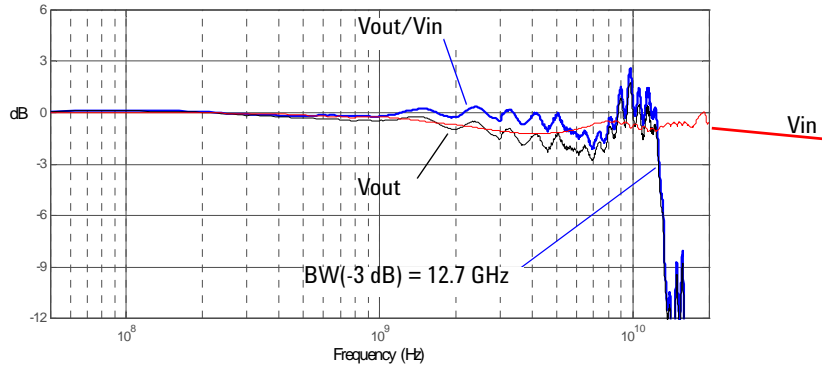

Figure 150 dB(Vin) and dB(Vout) + 10.8 dB of probe with a 25Ω source and dB(Vout/Vin) + 10.8 dB frequency response

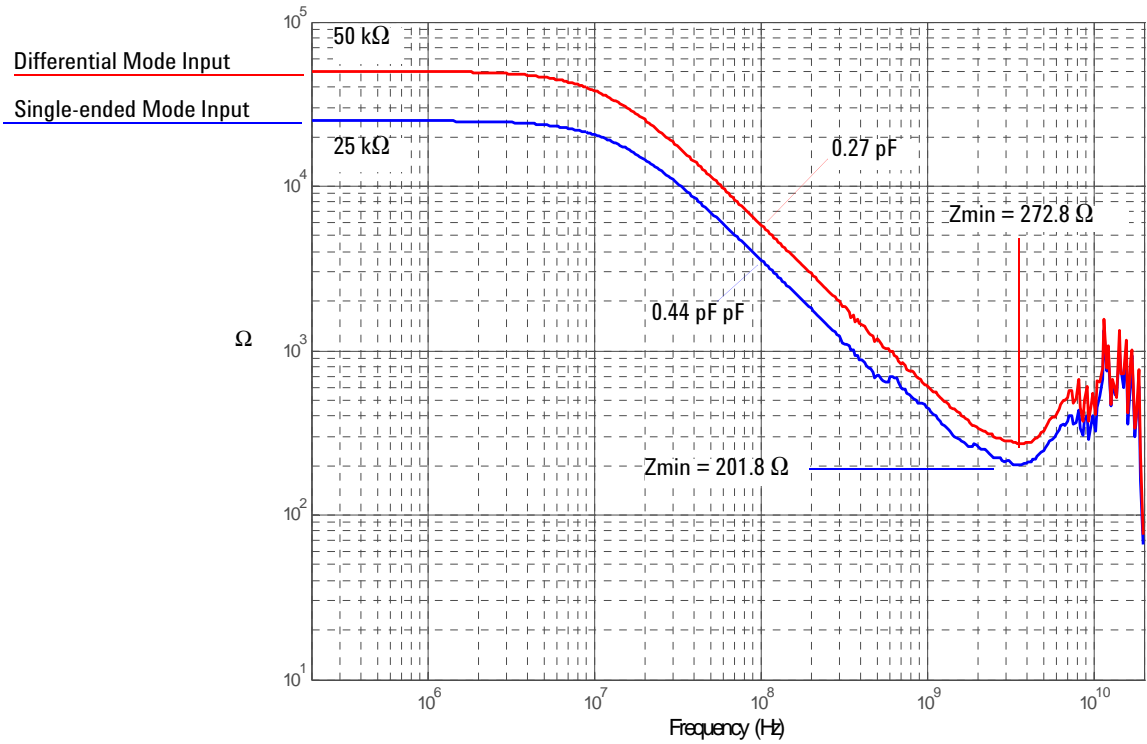

Figure 151 Magnitude plot of probe input impedance versus frequency

E2678A Differential Socketed Probe Head (High BW)

The following performance characteristic plots are for the 1169A probe using E2678A probe head.

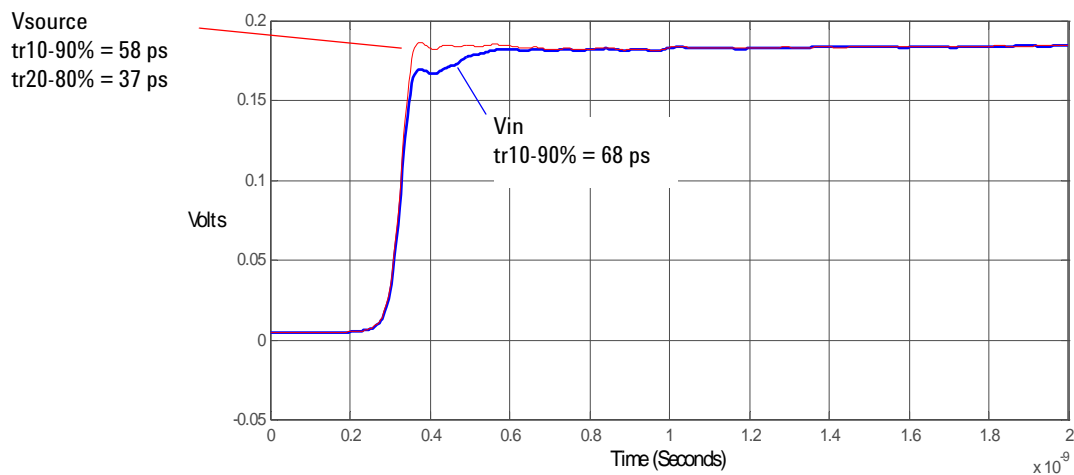

Figure 152 25 Ω 58 ps step generator with and without probe connected

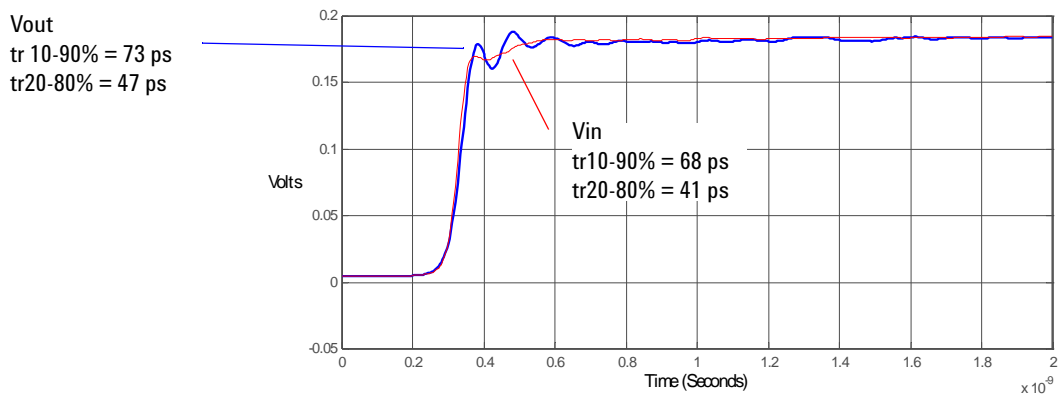

Figure 153 Vin and Vout of probe with a 25 Ω 58 ps step generator

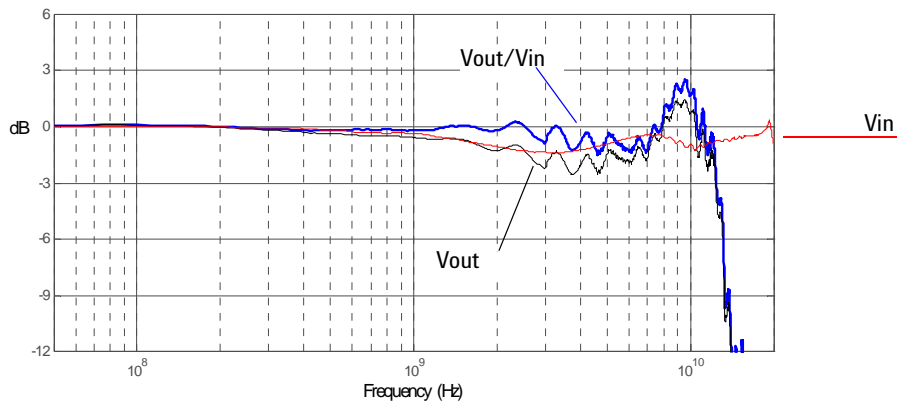

Figure 154 $\text{dB}(V_{in})$ and $\text{dB}(V_{out}) + 10.8 \text{ dB}$ of probe with a 25Ω source and $\text{dB}(V_{out}/V_{in}) + 10.8 \text{ dB}$ frequency response

6 Performance Plots

E2678A Differential Socketed Probe Head (High BW)

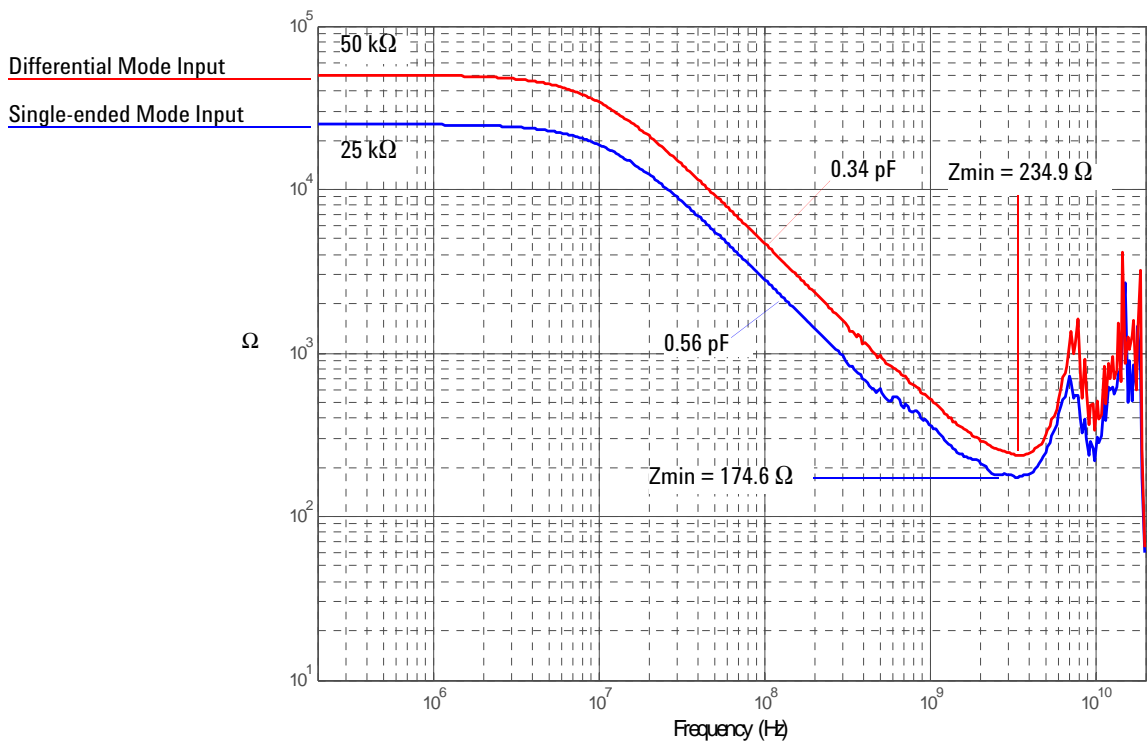

Figure 155 Magnitude plot of probe input impedance versus frequency

E2678A Differential Socketed Probe Head w/ Damped Wire

The following performance characteristic plots are for the 1169A probe using E2678A probe head with the damped wire accessory.

NOTE

Due to reflections on the long wire accessories, signals being probed should be limited to ~ 240 ps rise time measured at the 10% and 90% amplitude levels. This is equivalent to ~ 1.5 GHz bandwidth.

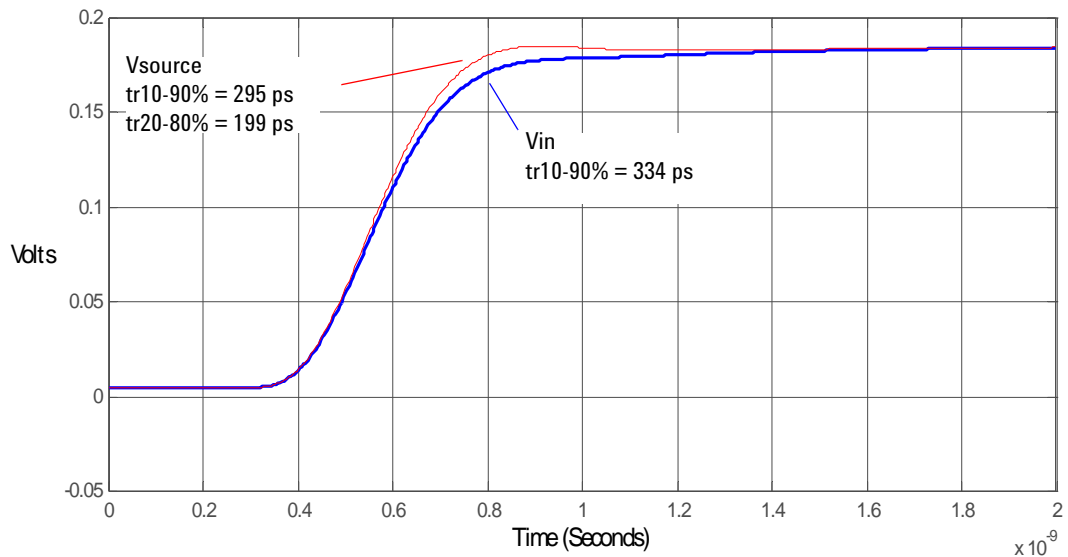

Figure 156 25Ω 295 ps step generator with and without probe connected

6 Performance Plots
E2678A Differential Socketed Probe Head w/ Damped Wire

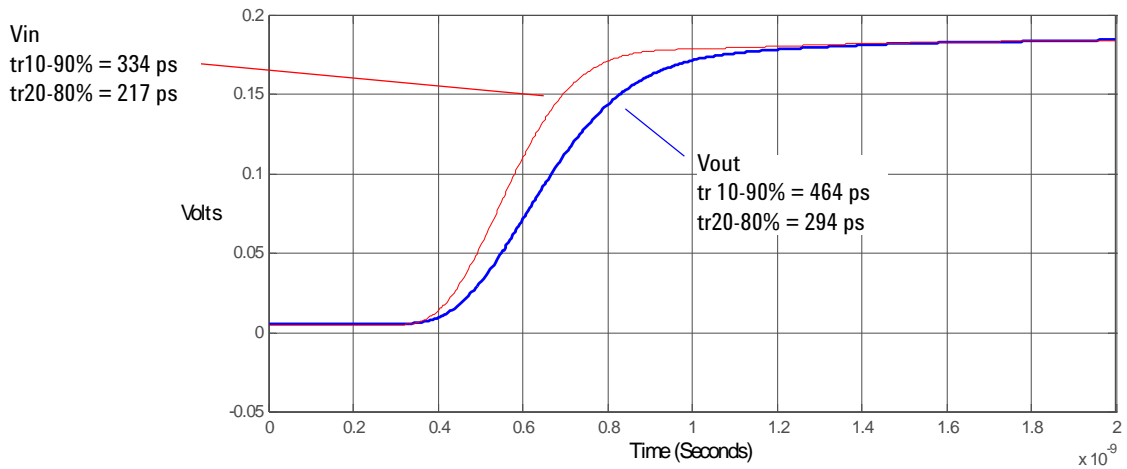

Figure 157 V_{in} and V_{out} of probe with a 25Ω 295 ps step generator

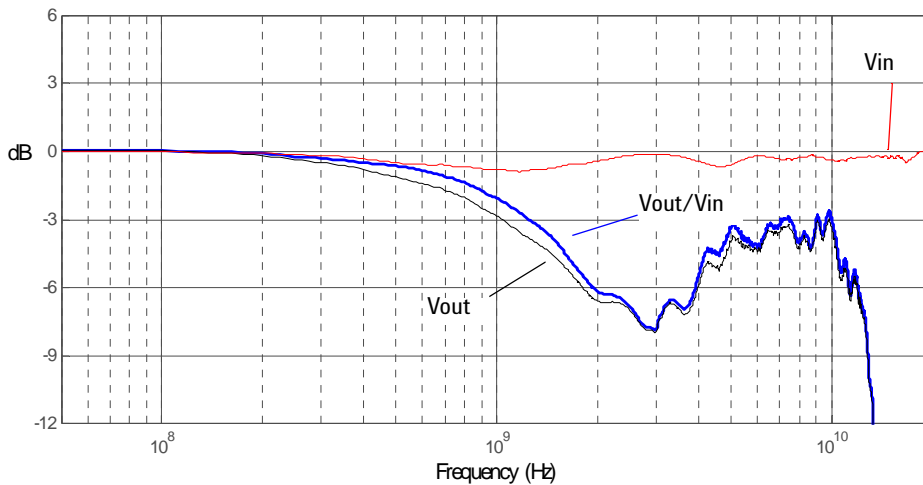

Figure 158 $\text{dB}(V_{in})$ and $\text{dB}(V_{out}) + 10.8 \text{ dB}$ of probe with a 25Ω source and $\text{dB}(V_{out}/V_{in}) + 10.8 \text{ dB}$ frequency response

E2678A Differential Socketed Probe Head w/ Damped Wire

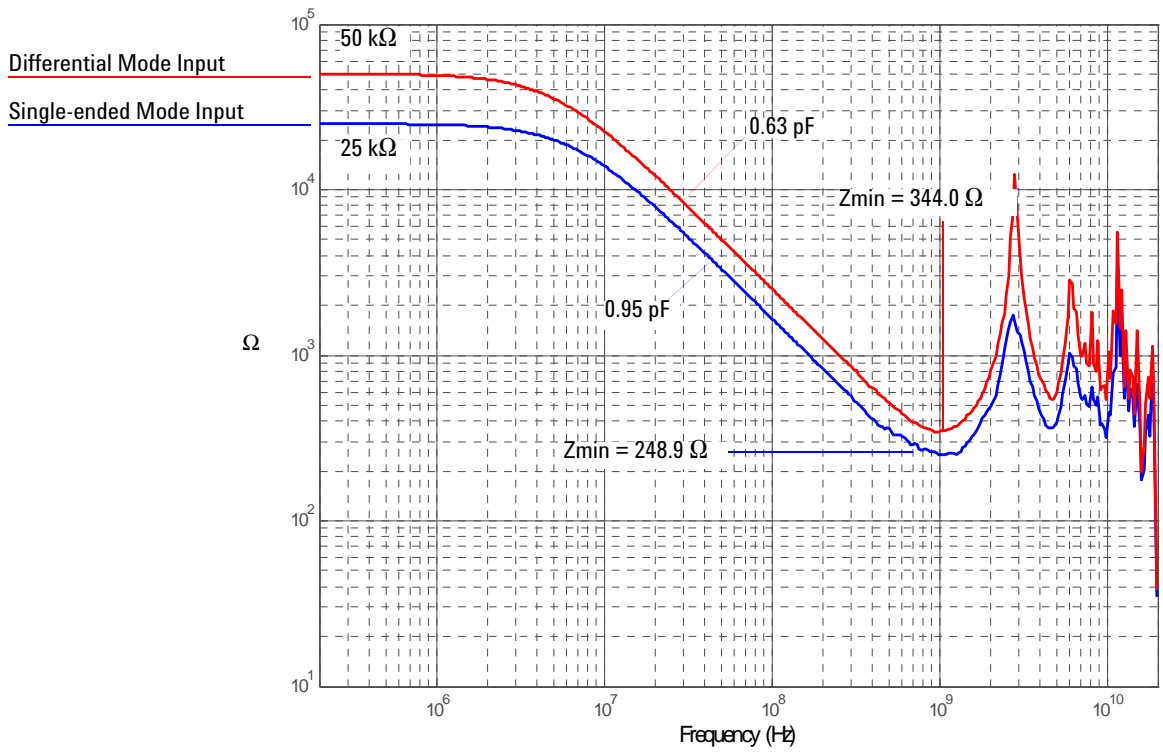

Figure 159 Magnitude plot of probe input impedance versus frequency

E2679A Single-Ended Solder-In Probe Head (High BW)

The following performance characteristic plots are for the 1169A probe using E2679A probe head.

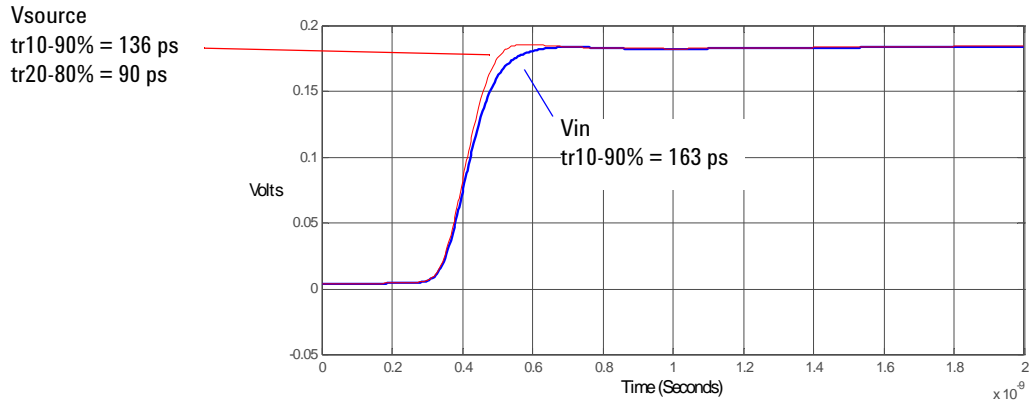

Figure 160 25Ω 136 ps step generator with and without probe connected

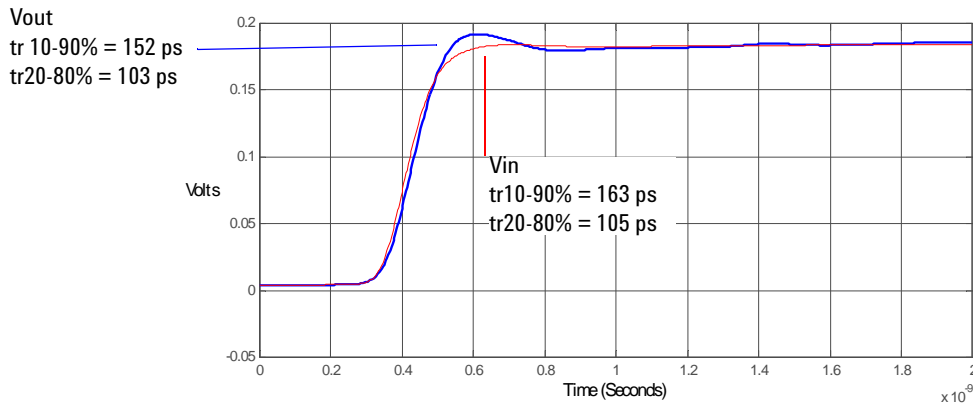

Figure 161 Vin and Vout of probe with a 25Ω 136 ps step generator

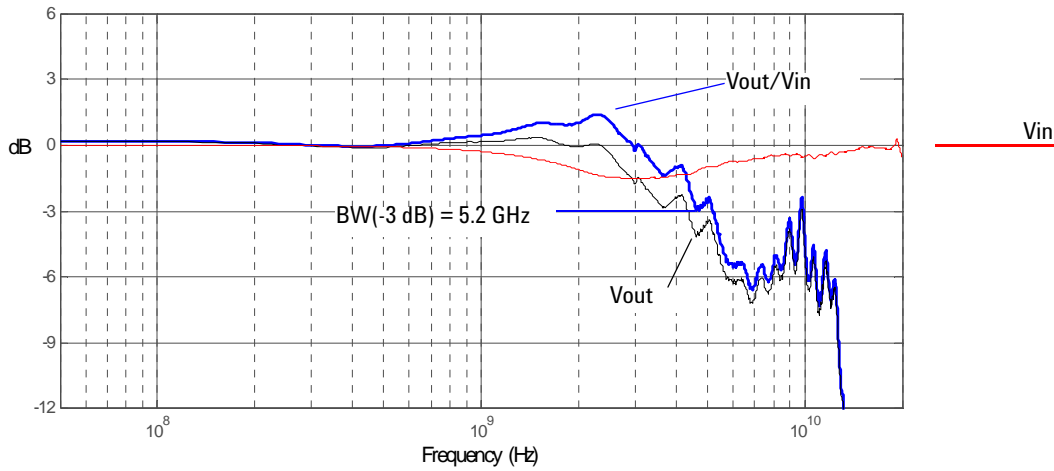

Figure 162 $\text{dB}(V_{in})$ and $\text{dB}(V_{out}) + 10.8\text{ dB}$ of probe with a 25Ω source and $\text{dB}(V_{out}/V_{in}) + 10.8\text{ dB}$ frequency response

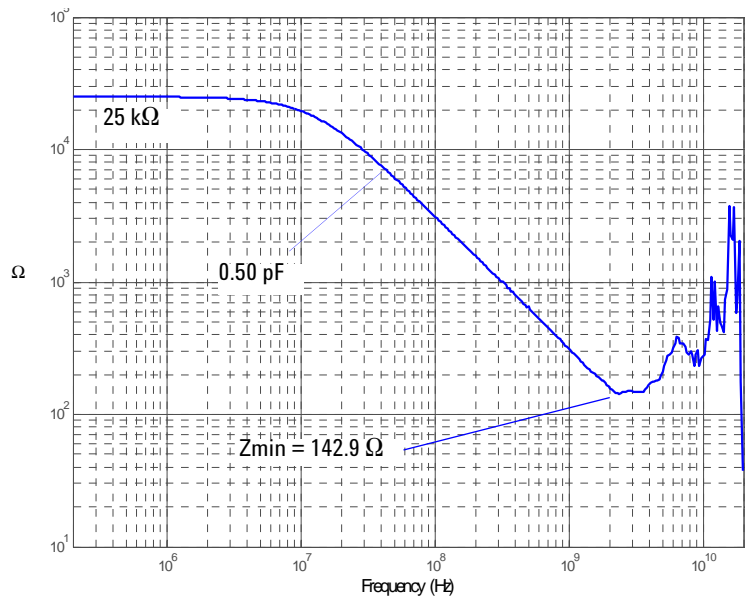

Figure 163 Magnitude plot of probe input impedance versus frequency

N2887A/N2888A Soft Touch Probe Heads

The following performance characteristic plots are for the 1169A probe using N2887/8A probe heads.

To properly interpret these plots, it is important to define what *differential* and *single-ended* means for these probe heads, as shown in Figure 164. Note that the single-ended configuration is not a differential probe probing a single-ended signal, but rather is a single-ended probe probing a single-ended signal.

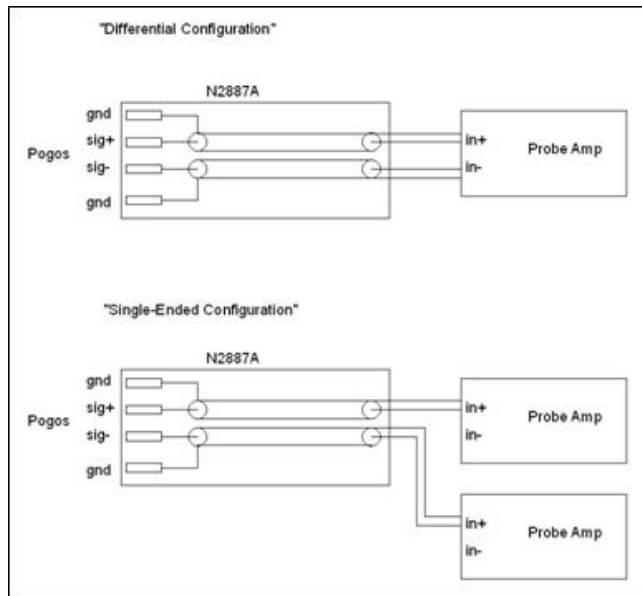

Figure 164 Differential and Single-ended Configurations

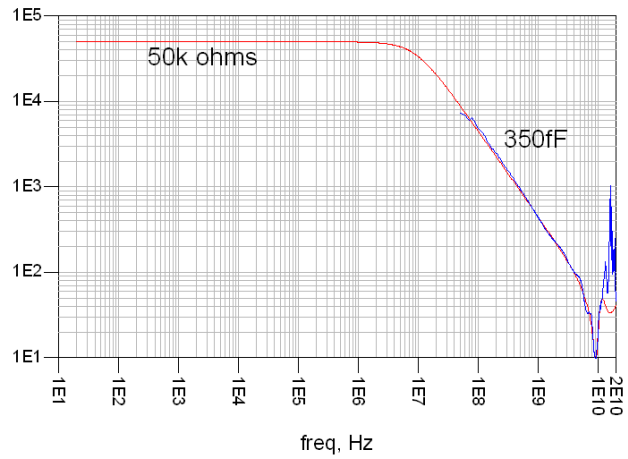

Figure 165 Differential input impedance (red = model, blue = measured)

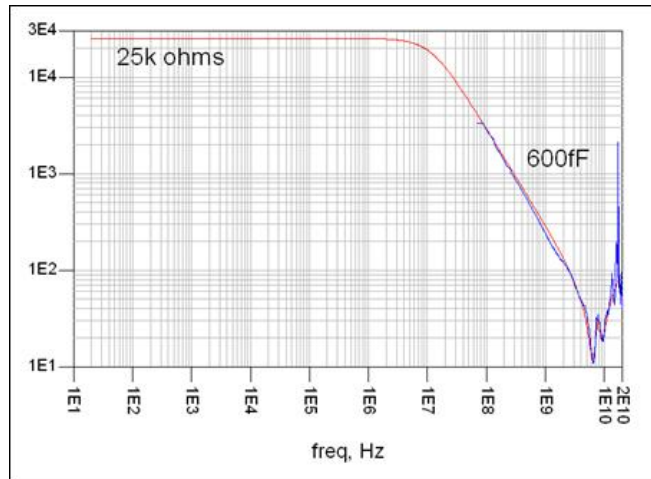

Figure 166 Single-ended input impedance (red = model, blue = measured)

6 Performance Plots
N2887A/N2888A Soft Touch Probe Heads

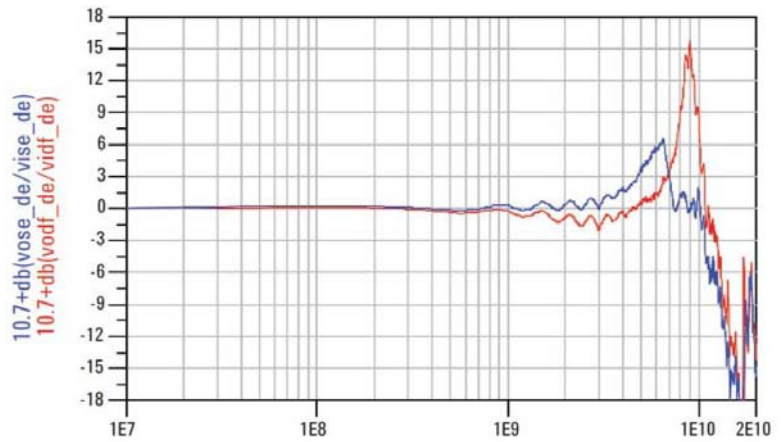
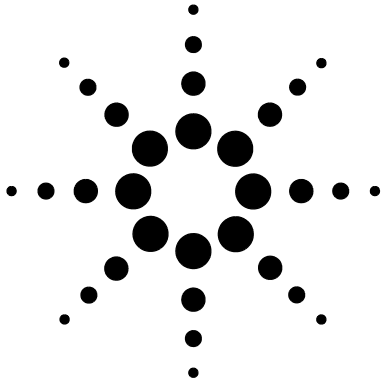

Figure 167 Frequency response, N2887A with an 1169A 12 GHz amplifier (**red** = differential, **blue** = single-ended)



7

Performance Verification

To Test Bandwidth 198

To Test Input Resistance 209

Performance Test Record 214

This chapter describes how to verify the bandwidth and input resistance performance of the probe.

CAUTION

Electrostatic discharge (ESD) can quickly and imperceptibly damage or destroy high performance probes, resulting in costly repairs. Always wear a wrist strap when handling probe components and ensure that cables are discharged before being connected.

NOTE

Allow the probe to warm up for at least 20 minutes.







To Test Bandwidth

This test ensures that the probe meets its specified bandwidth.

Table 24 Bandwidth

Probe	Specification
1169A	> 12 GHz
1168A	> 10 GHz

Table 25 Required Test Equipment

Test Equipment	Critical Specification	Model Number
Vector Network Analyzer (VNA)	13 GHz sweep range full 2 port cal Option 1D5	Agilent 8720ES 
Calibration Standards	No Substitute	Agilent 85052D
External Power Supply	No Substitute	Agilent 1143A 
AutoProbe Interface Adapter	No Substitute	Agilent N1022A/B 
Outside thread 3.5 mm (male) to 3.5 mm (female) adapter	No Substitute	Agilent 5062-1247
Cable (2)	3.5 mil; SMA; High Quality	Agilent 8120-4948
Cable	1.5 mil Probe Power Extension No Substitute	Agilent 01143-61602
PV/DS Test Board	No Substitute (In E2655C Kit)	Agilent E2655-66503 

Using the 8720ES VNA successfully

To test bandwidth, follow these guidelines when using the Vector Network Analyzer.

- Sometimes it may take a few seconds for the waveforms to settle completely. Allow time for waveforms to settle before continuing.
- Make sure all connections are tight and secure. If needed, use a vise to hold the cables and test board stable while making measurements.
- Be careful not to cross thread or force any connectors. This could be a very costly error to correct.

Procedure

- 1 Turn on the 8720ES VNA and let warm up for 20 minutes.
- 2 Press the green **[Preset]** key on the 8720ES VNA.
- 3 On the VNA, press the **[Power]** key and set the power to 0 dBm.
- 4 On the VNA, press the **[AVG]** key and then select the **Averaging Factor** screen key. Set averaging to 4.
- 5 On the VNA, press the **[Sweep Setup]** key and then press the **sweep type menu** screen key. Select the **log freq** screen key.
- 6 Connect the probe under test to the Auto Probe Adapter and power the probe using the 1143A power supply [Figure 168](#) on page 200. Install the outside thread adapter to the Auto Probe Adapter.

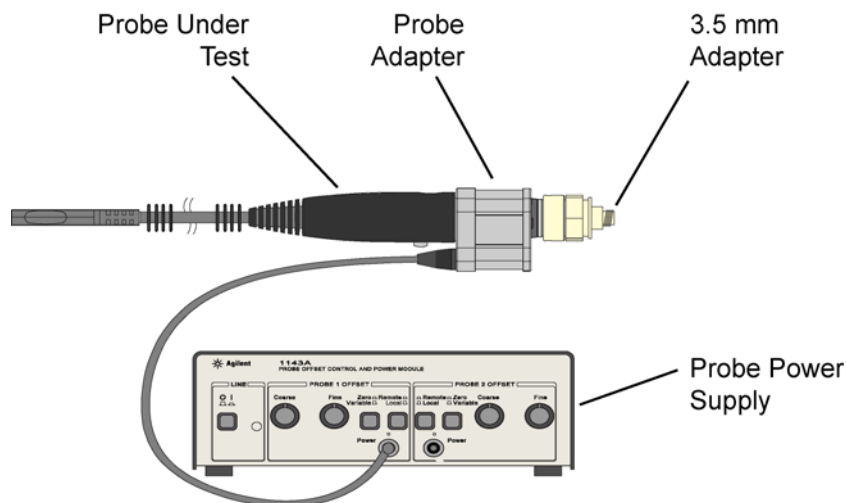

Figure 168 Probe Connected to Power Supply

Calibrating a Reference Plane

To get a reliable measurement from the VNA you must calibrate a reference plane so that the VNA knows where the probe under test is located along the transmission line.

- 7 On the VNA, press the **[Cal]** key.
- 8 Press the **cal menu** screen key.
- 9 Press the **full 2 port** screen key.
- 10 Connect one of the high quality SMA cables to port one and to the pincher side of PV/DS test board as shown in [Figure 169](#) on page 201.
- 11 The calibration reference plane is at the other end of PV/DS test board.
- 12 Perform a Calibration for the **PORT 1** side of the Reference plane.
 - a Press the **reflection** screen key.
 - b Connect the open end of 85052D Calibration Standard to the non-pincher side of the PV/DS test board.

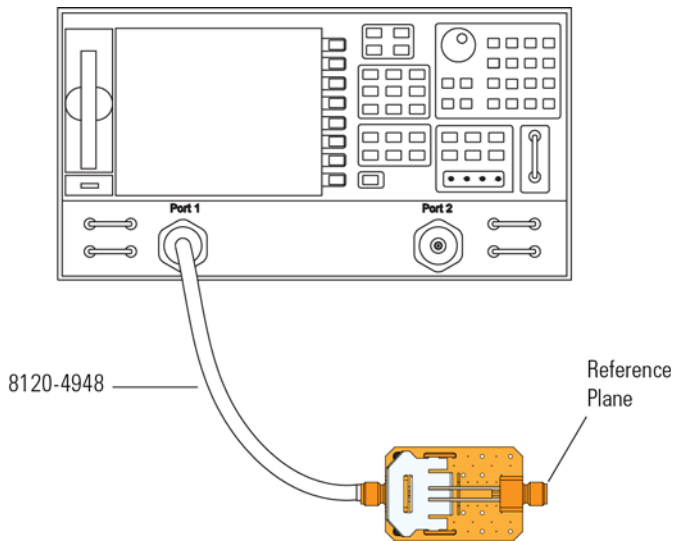

Figure 169 PV/DS Test Board Connected to VNA

- c** Select the **open** screen key under the **Forward** group.
- d** Wait until the VNA beeps indicating that it has completed the task.
- e** Connect short end of Calibration Standard to the non-pincher side of the PV/DS test board.
- f** Select **short** screen key under the **Forward** group.
- g** Wait until the VNA beeps indicating that it has completed the task.
- h** Connect load end of Calibration Standard to the non-pincher side of the PV/DS test board.
- i** Select the **loads** screen key under the **Forward** group.
- j** Press **broadband** screen key selection.
- k** Wait until the VNA beeps indicating that it has completed the task.
- l** Press the **done loads** screen key.
- m** You have just calibrated one side of the reference plane.

7 Performance Verification To Test Bandwidth

- 13 Connect the other high quality SMA cable to the VNA's **PORT 2** as shown in Figure 170.

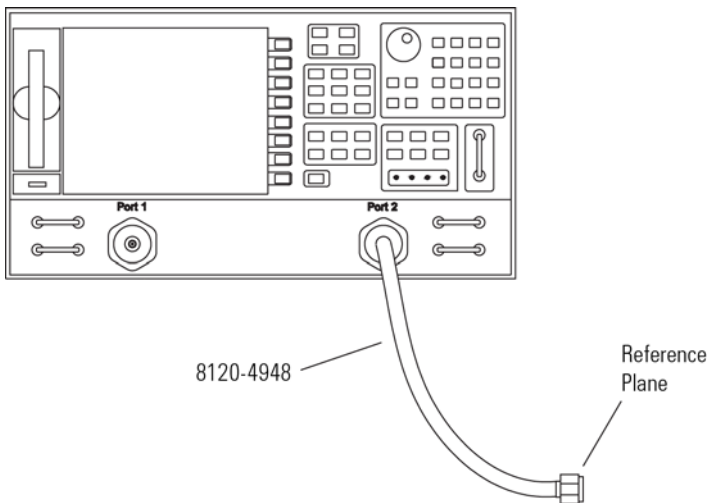

Figure 170 SMA Cable Connected to Port 2

- 14 Get the opposite sex of the Calibration Standards for the next step.
- 15 Perform Calibration for the **PORT 2** side of the Reference plane.
 - a Press the **reflection** screen key.
 - b Connect the open end of Calibration Standard to the available end of the **PORT 2** SMA cable.
 - c Select the **open** screen key under the **Reverse** group.
 - d Wait until the VNA beeps indicating that it has completed the task.
 - e Connect short end of Calibration Standard to the available end of the **PORT 2** SMA cable.
 - f Select **short** screen key the **Reverse** group.
 - g Wait until the VNA beeps indicating that it has completed the task.

- h** Connect load end of Calibration Standard to the available end of the **PORT 2** SMA cable.
- i** Select the **loads** screen key the **Reverse** group.
- j** Press **broadband** screen key selection.
- k** Wait until the VNA beeps indicating that it has completed the task.
- l** Press the **done loads** screen key.
- m** You have just calibrated the other side of the reference plane.
- 16** Press **standards done** key.
- 17** Connect port two SMA cable to the non-pincher side of PV/DS test board.

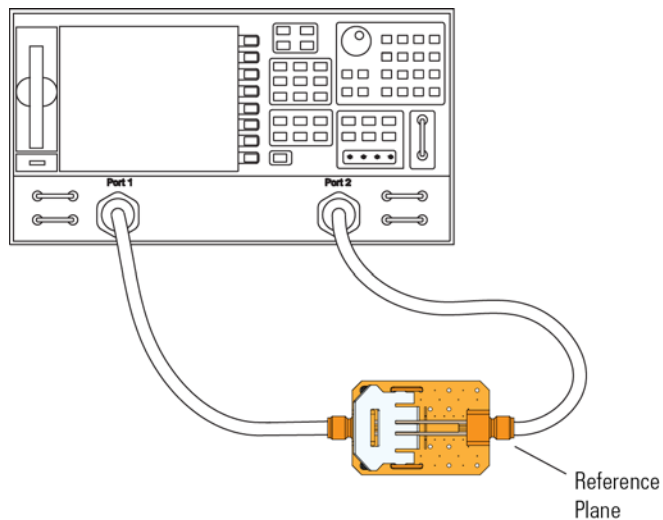

Figure 171 Forward and Reverse Setup

- 18** Press the **transmission** screen key.
- 19** Press the **do both fwd and reverse** screen key.
- 20** Wait until the VNA beeps *four* times indicating that it has completed the task.
- 21** Press the **isolation** screen key.

7 Performance Verification To Test Bandwidth

- 22 Press the **omit isolation** screen key.
- 23 Press **done 2 port cal** screen key.
- 24 Set the VNA's averaging to off.
- 25 Save the reference plane cal by pressing the [**save recall**] key then the [**save state**] key.
- 26 You may change name if you wish.
- 27 Press the [**scale reference**] key. Then set the scale to 1 dB per division and the reference position for 7 divisions.
- 28 Set reference value for 0 dB.
- 29 Press the [**measure**] key.
- 30 Press the **s21** screen key.
- 31 Ensure s21 response on screen is flat (about ± 0.1 dB) out to 13 GHz.

Measuring Vin Response

- 32 Position the probe conveniently to make quality connections on the PV/DS board as shown in [Figure 172](#).

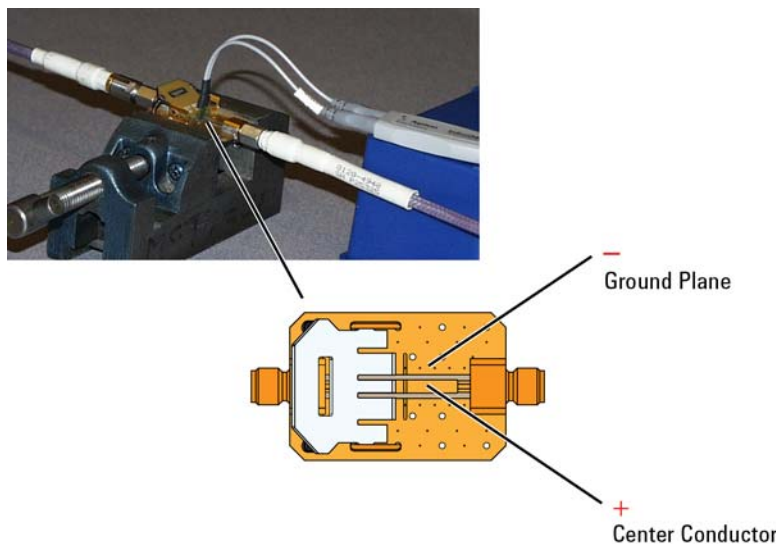

Figure 172 Probing Locations on PV Fixture

- 33** Spread the probe tip wires slightly so that the tips are a little bit wider than the gap between the signal trace and the ground on PV/DS board.

NOTE

To best simulate the conditions that are present when the probe is in actual use, inset only the tips of the wires under the pincher. Do not inset the wires completely under the pincher such that the contact points are right next to the tip of the PC board. The best way to accomplish this is to insert the wires under the pincher with the probe head at a 45° angle with respect to the PV/DS board, then apply upward pressure to the clip to hold the tip wires firmly. Gently pull the probe head up to the 90° position. This will actually form the wires into an "L" shape.

- 34** Place the probe's positive (+) side on center conductor and negative (-) side to ground as shown in the figure.
- 35** Press the [**Sweep Setup**] key on the VNA. Then press the **trigger menu** screen key. Select the **continuous** screen key.
- 36** The V_{in} waveform shown on screen should be similar to that shown in **Figure 173**.

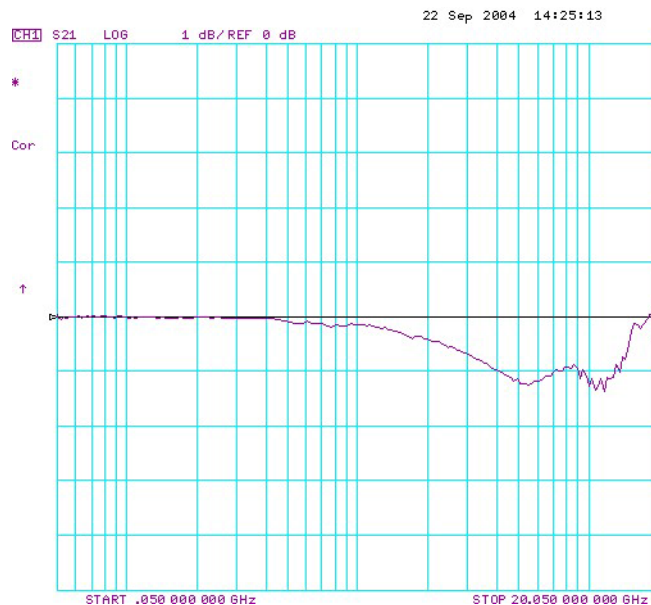

Figure 173 Typical V_{in} Waveform

7 Performance Verification To Test Bandwidth

- 37 Select [**display**] key then **data->memory** screen key.
- 38 You have now saved V_{in} waveform into the VNA's memory for future use.

Measuring V_{out} Response

- 39 Disconnect the **PORT 2** cable from PV/DS test board and attach to probe output on the AutoProbe Adapter.
- 40 Connect the Calibration Standard load to PV/DS test board (non-pincher side) as shown in [Figure 174](#).

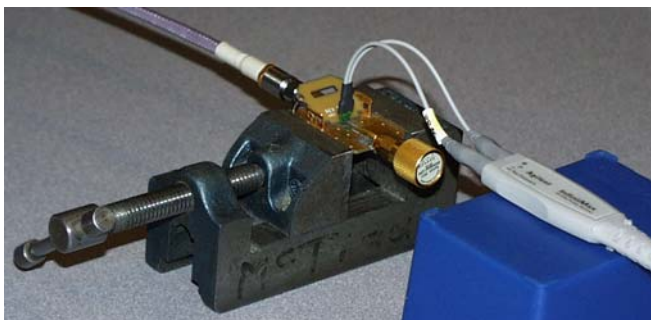

Figure 174 Setup for Measuring V_{out}

- 41 Press [**scale reference**] key on the VNA.
- 42 Set reference value to -10.8 dB.
- 43 The display on screen is V_{out} and it should be similar to that shown in [Figure 175](#).

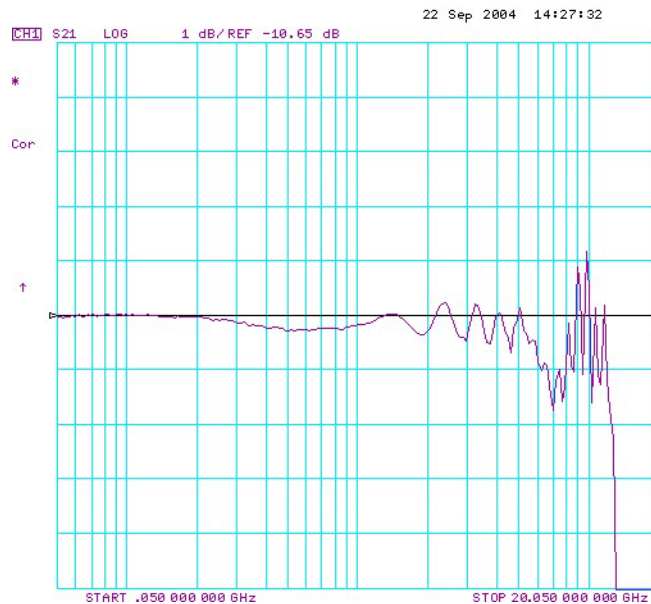

Figure 175 Typical V_{out} Waveform for an 1134A Probe

Displaying V_{out}/V_{in} Response on the VNA

- 44** Press the **[Display]** key.
- 45** Then select the **Data/Memory** screen key. You may need to adjust the **Reference Value**, located under the **Scale Ref** key, slightly to position the waveform at center screen at 100 MHz. The waveform should be similar to that shown in Figure 176.

7 Performance Verification To Test Bandwidth

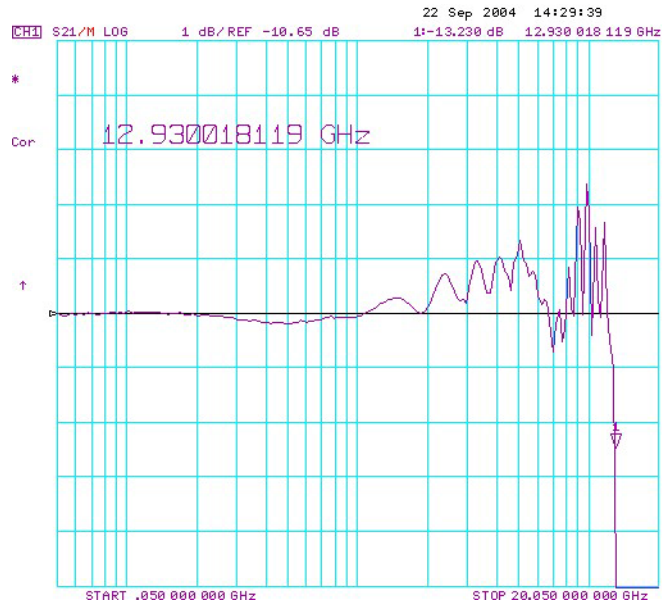

Figure 176 Typical Waveform for an 1134A Prob

- 46 Press marker key and position the marker to the first point that the signal is -2.6 dB below center screen. Minus 2.6 dB is used rather than -3 dB because the loss caused by the PV/DS board makes a slightly optimistic measurement.
- 47 Read marker frequency measurement and record it in the test record located later in this chapter.
- 48 The bandwidth test passes if the frequency measurement is greater than the probe's bandwidth limit. Record the bandwidth in Table 28 on page 214.

To Test Input Resistance

This procedure tests that the probe meets its specified input resistance.

Table 26 Input Resistance

Mode	Specification
Differential Mode	50 k Ω \pm 2%
Single-Ended Mode	25 k Ω \pm 2%

Table 27 Required Test Equipment

Test Equipment	Critical Specification	Model Number
Oscilloscope	No substitute. Requires precision BNC connectors	DSO90000 Series Infiniium Oscilloscope
Digital Multimeter	2 wire resistance accuracy > \pm 0.01%	34401A
Adapter	BNC (f) to SMA(m) (In E2655C Kit)	E2655-83201
PV/DS Test Board	No Substitute (In E2655C Kit)	Agilent E2655-66503 

Procedure

- 1** Power on the Infiniium oscilloscope and 34401A DMM.
- 2** Connect the probe under test to Channel 1 of the Infiniium oscilloscope.
- 3** Select the 2-wire Ohm display on the 34401A DMM.

7 Performance Verification
To Test Input Resistance

Differential Test

- 1 Using the PV/DS test board, connect the positive (+) and negative (-) probe tips to the 34401A DMM.

NOTE Apply upward pressure to the clip to ensure proper electrical connection.

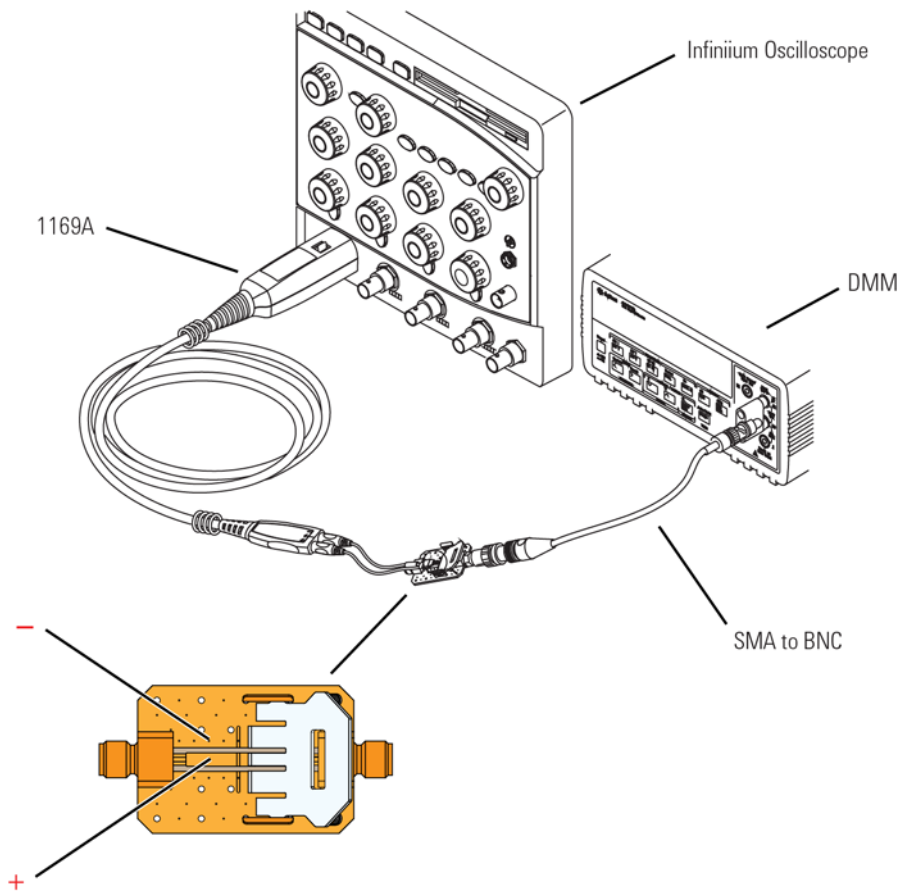

Figure 177 Probing Locations on PV Test Board for Differential Test

- 1 Read the 34401A display for the input resistance.
- 2 Record the result in the performance test record later in this chapter. To pass this test the result should be between 49 k Ω and 51 k Ω .

Single-ended Test

- 1 Using the PV/DS test board, connect the positive (+) probe tip to the 34401A DMM as shown in [Figure 178](#) on page 212. Connect the probe's amplifier body ground to the PV/DS test board ground.

NOTE

Apply upward pressure to the clip to ensure proper electrical connection.

- 2 Read the 34401A display for the input resistance.
- 3 Record the result in the performance test record later in this chapter. To pass this test the result should be between 24.5 k Ω and 25.5 k Ω .

7 Performance Verification To Test Input Resistance

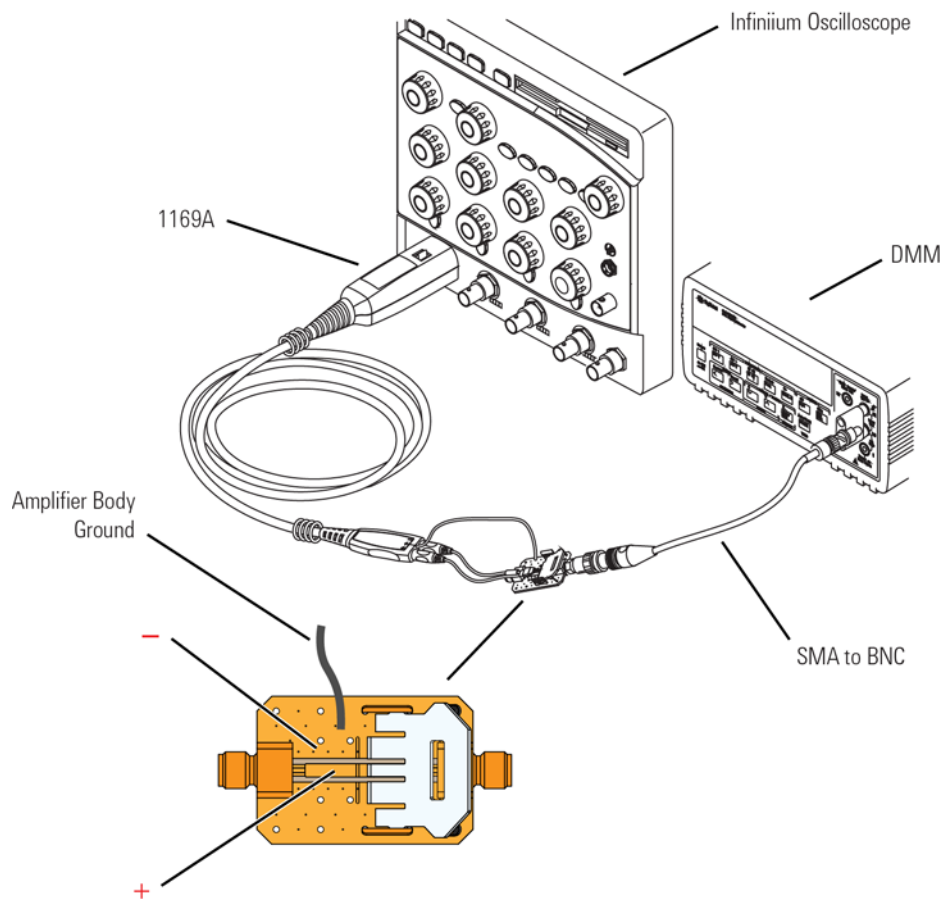

Figure 178 Probing Locations on PV Test Board for Differential Test

- 4 Using the PV/DS test board, connect the negative (-) probe trip to the DMM.

NOTE

Apply upward pressure to the clip to ensure proper electrical connection.

- 5 Connect the probe's amplifier body to ground on the PV/DS test board as shown in [Figure 179](#) on page 213.

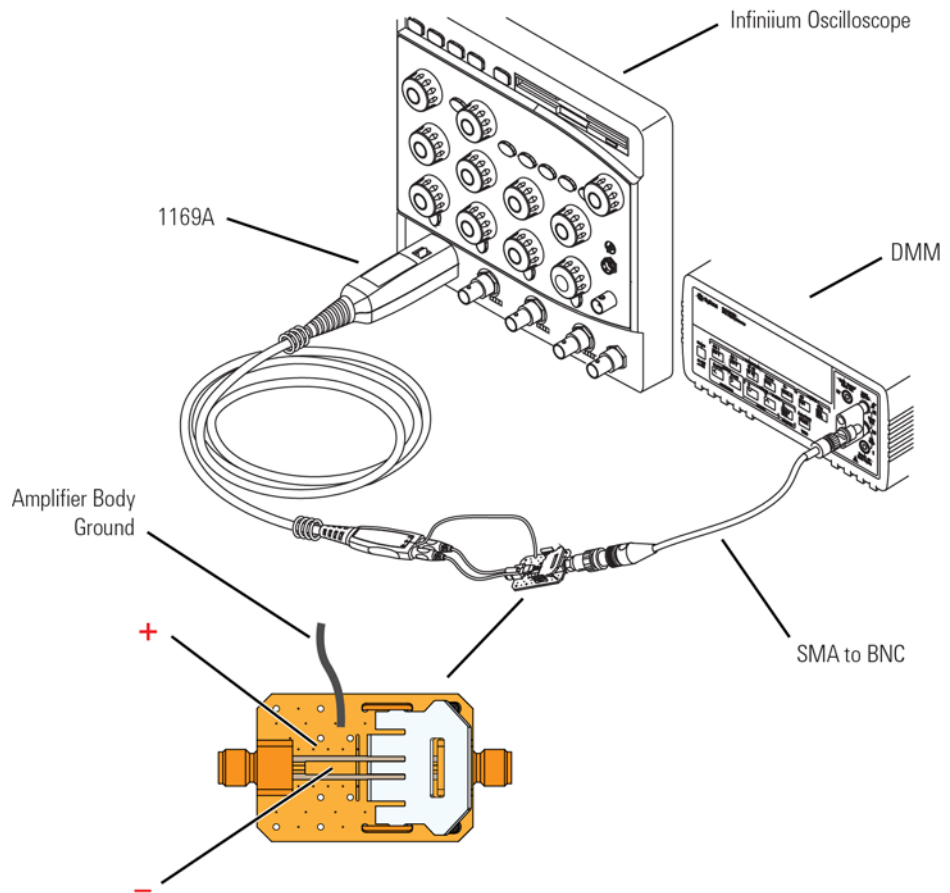

Figure 179 Probing Locations on PV Test Board for Differential Test

- 6 Read the input resistance on the DMM. Record the input resistance in [Table 28](#) on page 214.

Performance Test Record

Table 28 Performance Test Record

Model #:	Date:	Tested by:	
Serial #:	Recommended next test date:		
Test	Test Limits	Result	Pass/Fail
Bandwidth	> 12 GHz (1169A) > 10 GHz (1168A)		
Input Resistance	50 k Ω \pm 2% (Differential Mode) 25 k Ω \pm 2% (Single-ended Mode)		

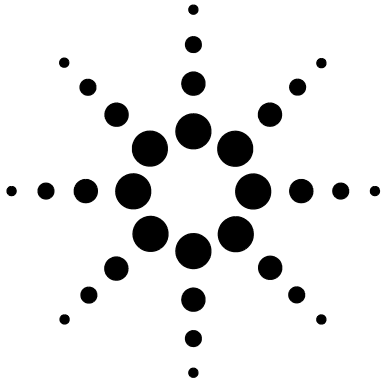

8

SPICE Models

N5381A and N5382A Heads	217
N5425A ZIF Head with N5426A ZIF Tip Attached	220
N5426A ZIF Tip	223
N5425A ZIF Head with N5451A Long-Wire ZIF Tip	226
N2887A/N2888A Heads	235
InfiniiMax I Heads	238
SPICE Model for Differential Heads	239
SPICE Model for Single-Ended Heads	240
SPICE Deck and Measured/Modeled Data Matching	241
E2675A Differential Browser Probe Head	241
E2678A Differential Socket Tip Head	242
E2677A Differential Solder-In Head	244
E2676A Single-Ended Browser Head	245
E2679A Single-Ended Solder-In Head	246

This document contains SPICE models that can be used to predict the probe loading effects of the InfiniiMax II active probes. Important points about these SPICE models are:

- SPICE models shown here are only for input impedance which allows modeling of the probe loading effects. Probe transfer function is generally flat to the specified bandwidth.



- These input impedance is a function of the probe head type only. The probe amp bandwidth (10 GHz 1168A or 12 GHz 1169A) does not have any effect on the input impedance of the probe heads.

An input impedance plot is given that shows the matching of the measured data to the modeled data. Matching is generally very good up to the specified bandwidth of the probe head.

N5381A and N5382A Heads

*SPICE Model for InfiniiMax 1160 Series
*N5381A (&N5382A) Differential Probe Heads

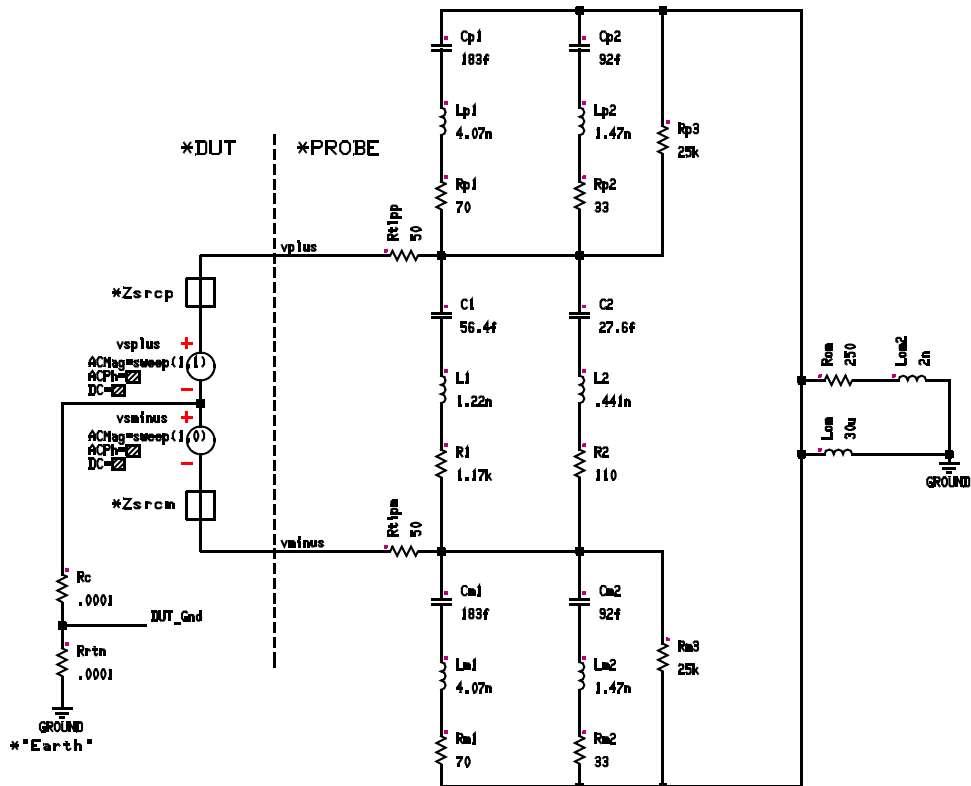

Rrtn (or Zrtn) is dependent on connection from DUT ground to "Earth" ground. Most likely modeled by a parallel RL similar to Rom || Lom. Will have slight effect on single-ended input Z and no effect on differential input Z.

When using differential probe to probe single-ended signals:

- vplus connected to DUT signal
- vminus connected to DUT ground which means that $R_c = 0$, $v_{sminus} = 0$, and $Z_{srcm} = 0$.
- Input impedance is defined to be $vplus/i(vplus)$
- When using differential probe to probe differential signals:
- R_c (or Z_c) will depend on the DUT circuit.
- vplus connected to DUT plus signal
- vminus connected to DUT minus signal.
- Input impedance is defined to be $(vplus - vminus)/i(vplus)$

SPICE Deck

```

C2 %44 %40 27.6f
Cm2 %41 %38 92f
Cp2 %43 %36 92f
Cp1 %43 %34 183f
Cm1 %41 %31 183f
C1 %44 %28 56.4f
vsminus %16 %vminus ACMag=sweep(1,0)
vsplus %vplus %16 ACMag=sweep(1,1)
Lom2 %47 %0 2n
Lom %43 %0 30u
L2 %40 %39 .441n
Lm2 %38 %37 1.47n
Lp2 %36 %35 1.47n
Lp1 %34 %33 4.07n
Lm1 %31 %30 4.07n
L1 %28 %32 1.22n
Rm3 %41 %43 25k
Rp3 %43 %44 25k
Rom %43 %47 250
R2 %39 %41 110
Rm2 %37 %43 33
Rp2 %35 %44 33
Rp1 %33 %44 70
Rm1 %30 %43 70
R1 %32 %41 1.17k
Rtipm %vminus %41 50
Rtipp %vplus %44 50
Rrtn %15 %0 .0001

```

```
Rc %16 %15 .0001
.END
```

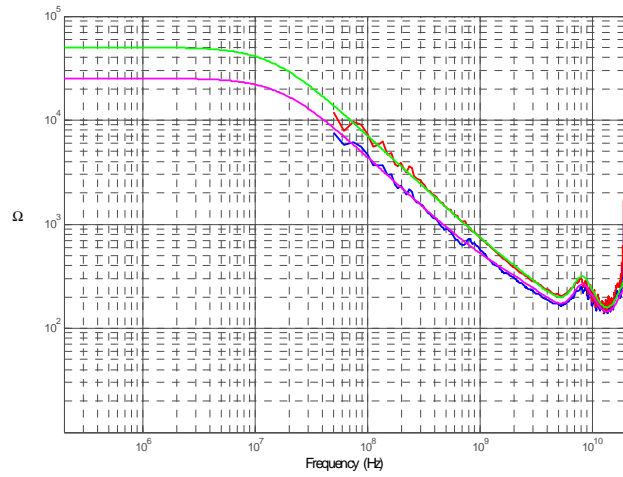
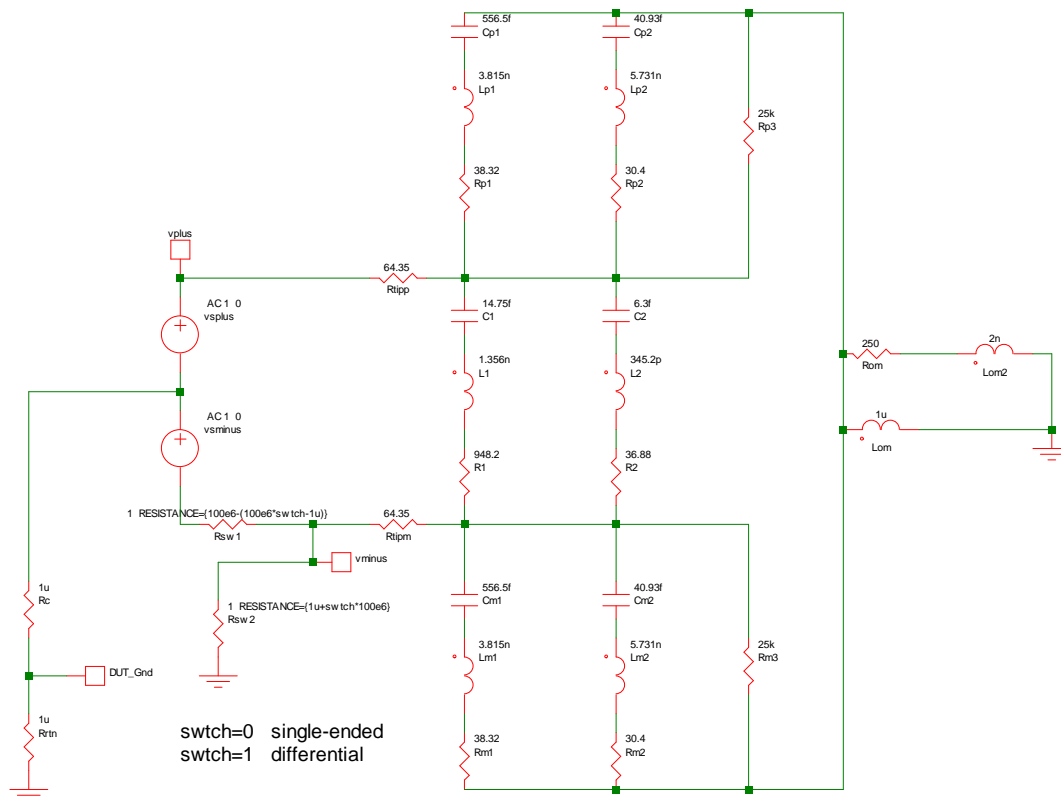

Figure 180 Measured and Modeled Data Matching

N5425A ZIF Head with N5426A ZIF Tip Attached



When using differential probe to probe single-ended signals:

- vplus connected to DUT signal
- vminus connected to DUT ground which means that $R_{sw1} = \infty$ and $R_{sw2} = 0$
- Input impedance is defined to be $v_{plus}/i(v_{plus})$
- When using differential probe to probe differential signals:
- R_c (or Z_c) will depend on the DUT circuit.

- vplus connected to DUT plus signal
- vminus connected to DUT minus signal.
- Input impedance is defined to be $(vplus - vminus)/i(vplus)$

SPICE Deck of N5425A with N5426A ZIF Tip Attached

```

Lom2 Rom_P 0 2n
Lm2 Cm2_N Lm2_N 5.731n
Rtipp Rp3_N vplus 64.35
Lm1 Cm1_N Lm1_N 3.815n
Rom Rom_P Cp1_P 250
Cp1 Cp1_P Cp1_N 556.5f
Cp2 Cp1_P Cp2_N 40.93f
Lp1 Cp1_N Lp1_N 3.815n
Lp2 Cp2_N Lp2_N 5.731n
Cm2 R1_N Cm2_N 40.93f
vsminus vsplus_N vsminus_N AC 1 0
L1 C1_N L1_N 1.356n
L2 C2_N L2_N 345.2p
Rp1 Lp1_N Rp3_N 38.32
Cm1 R1_N Cm1_N 556.5f
Rp2 Lp2_N Rp3_N 30.4
Rp3 Cp1_P Rp3_N 25k
Rrtn DUT_Gnd 0 1u
Rsw2 vminus 0 1 1u+swtch*100e6
vsplus vplus vsplus_N AC 1 0
Rm2 Lm2_N Cp1_P 30.4
Rm3 R1_N Cp1_P 25k
Rsw1 vminus vsminus_N 100e6-(100e6*swtch-1u)
Lom Cp1_P 0 1u
C2 Rp3_N C2_N 6.3f
Rm1 Lm1_N Cp1_P 38.32
Rc vsplus_N DUT_Gnd 1u
C1 Rp3_N C1_N 14.75f
Rtipm R1_N vminus 64.35
R1 L1_N R1_N 948.2
R2 L2_N R1_N 36.88
.AC DEC 200 200k 20G SWEEP PARAM=swtch LIN 2 0 1
.PARAM swtch=1

```

8 SPICE Models
N5425A ZIF Head with N5426A ZIF Tip Attached

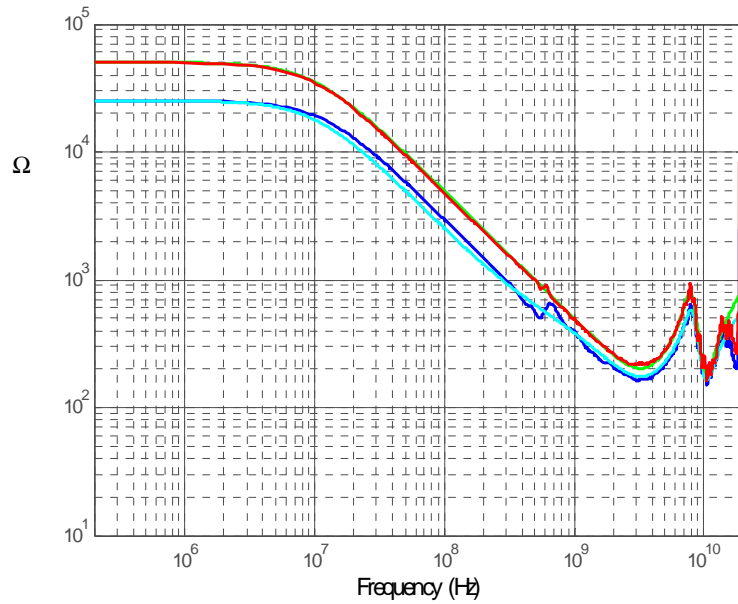
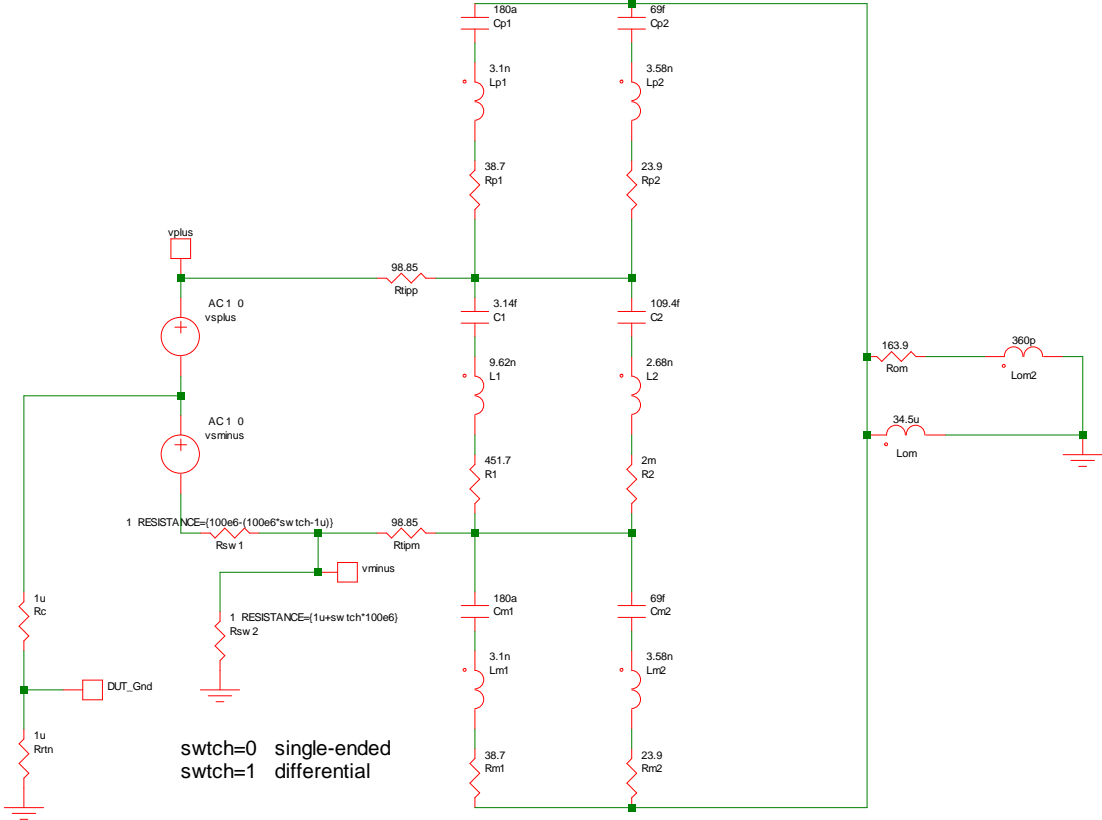

Figure 181 Measured and Modeled Data Matching

N5426A ZIF Tip



SPICE Deck of N5426A

```
Lom2 Rom_P 0 360p
Lm2 Cm2_N Lm2_N 3.58n
Rtipp Rp3_N vplus 98.85
Lm1 Cm1_N Lm1_N 3.1n
Rom Rom_P Cp1_P 163.9
Cp1 Cp1_P Cp1_N 180a
Cp2 Cp1_P Cp2_N 69f
Lp1 Cp1_N Lp1_N 3.1n
Lp2 Cp2_N Lp2_N 3.58n
Cm2 R1_N Cm2_N 69f
vsminus vsplus_N vsminus_N AC 1 0
L1 C1_N L1_N 9.62n
L2 C2_N L2_N 2.68n
Rp1 Lp1_N Rp3_N 38.7
Cm1 R1_N Cm1_N 180a
Rp2 Lp2_N Rp3_N 23.9
Rrtn DUT_Gnd 0 1u
Rsw2 vminus 0 1 RESISTANCE={1u+swtch*100e6}
vsplus vplus vsplus_N AC 1 0
Rm2 Lm2_N Cp1_P 23.9
Rsw1 vminus vsminus_N 1 RESISTANCE={100e6-(100e6*swtch-1u)}
Lom Cp1_P 0 34.5u
C2 Rp3_N C2_N 109.4f
Rm1 Lm1_N Cp1_P 38.7
Rc vsplus_N DUT_Gnd 1u
C1 Rp3_N C1_N 3.14f
Rtipm R1_N vminus 98.85
R1 L1_N R1_N 451.7
R2 L2_N R1_N 2m
.AC DEC 200 200k 20G SWEEP PARAM=swtch LIN 2 0 1
.PARAM swtch 1
```

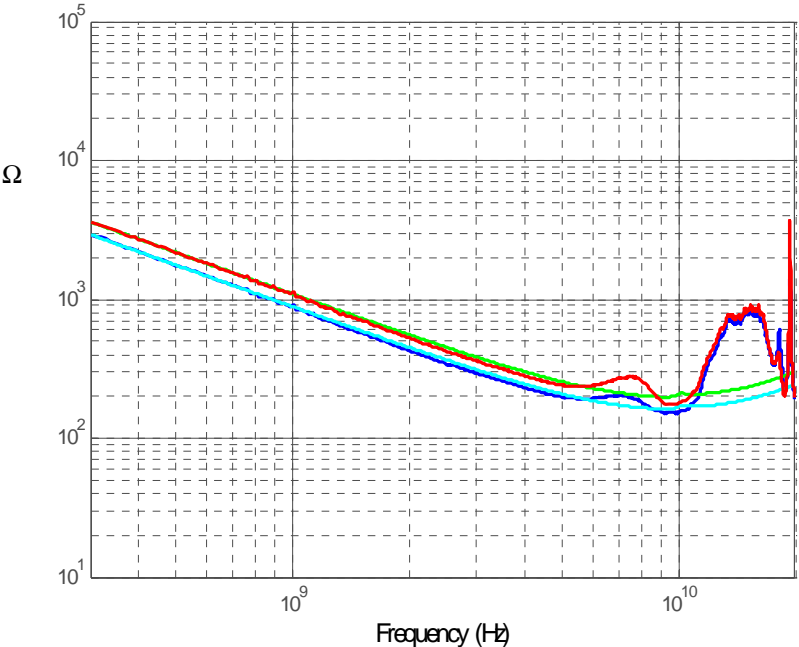
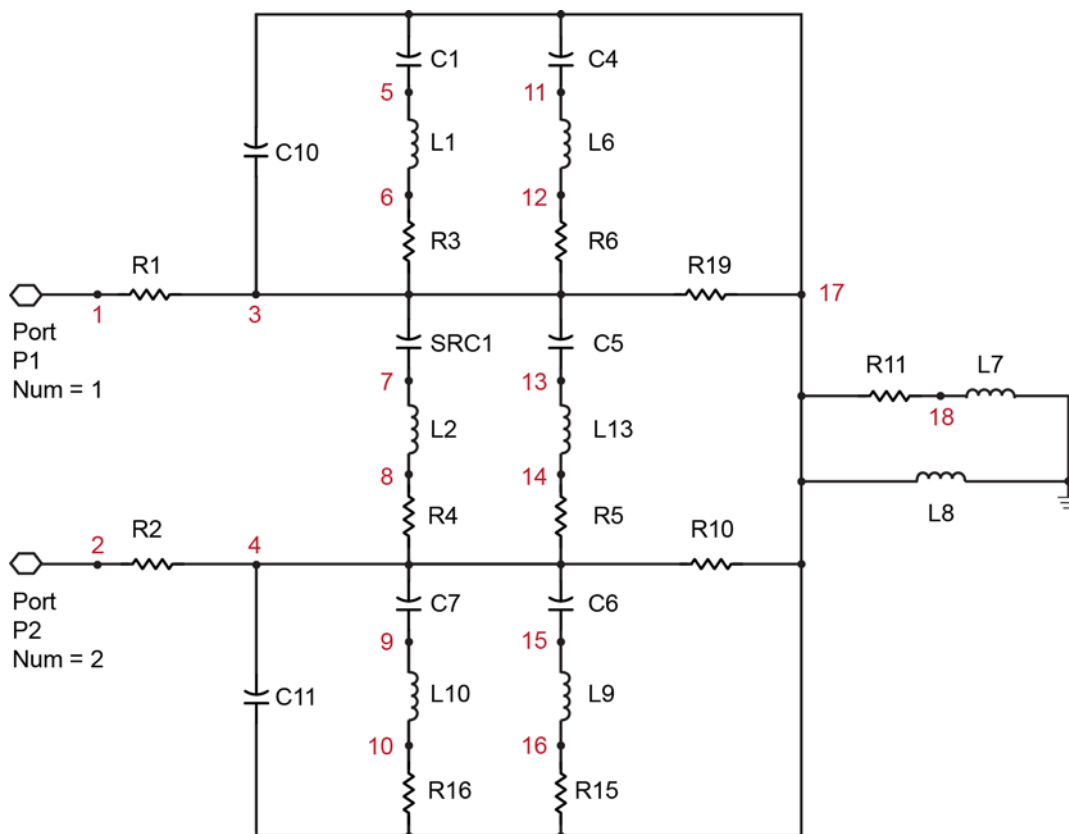



Figure 182 Measured and Modeled Data Matching

N5425A ZIF Head with N5451A Long-Wire ZIF Tip



To model single-ended input impedance, ground one input pin and apply the signal to the other input pin.

To model differential input impedance, connect both input pins to the differential signal.

**SPICE Deck with
N5451A ZIF Tip
(7 mm Lead and 0° Spread)**

```
* Input impedance SPICE subckt for probe head listed.
.subckt N5451A_N5425A_7mm_0deg 1 2
r1 1 3 49.5
r2 2 4 49.5
c10 3 17 10.74f
c11 4 17 10.74f
c1 17 5 330f
c7 4 9 330f
l1 5 6 8.81n
l10 9 10 8.81n
r3 6 3 83.6
r16 10 17 83.6
csrc1 3 7 164.4f
l2 7 8 22.1n
r4 8 4 195.7
c4 17 11 71.3f
c6 4 15 71.3f
l6 11 12 3.46n
l9 15 16 3.46n
r6 12 3 65.0
r15 16 17 65.0
c5 3 13 26.1f
l13 13 14 4.28n
r5 14 4 42.3
r19 3 17 25k
r10 4 17 25k
r11 17 18 60.6
l7 18 0 .05n
l8 17 0 45.5u
ends
```

8 SPICE Models

N5425A ZIF Head with N5451A Long-Wire ZIF Tip

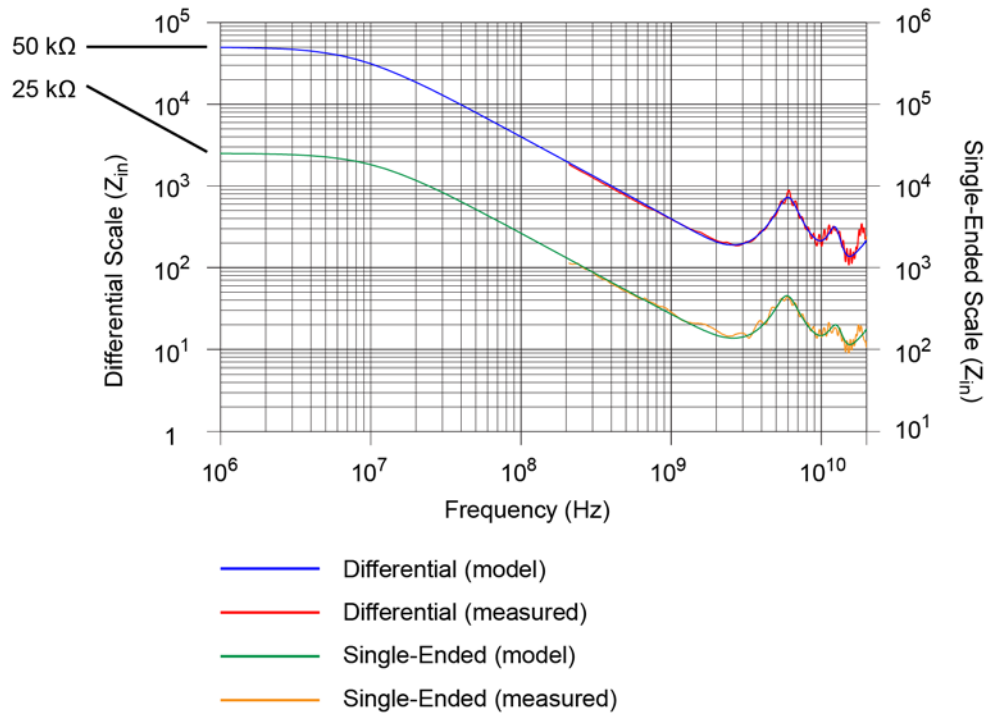

Figure 183 Measured and Modeled Data Matching for 7 mm Leads and 0° Spread

N5425A ZIF Head with N5451A Long-Wire ZIF Tip

**SPICE Deck with
N5451A ZIF Tip
(7 mm Lead and 60° Spread)**

```

* Input impedance SPICE subckt for probe head listed.
.subckt N5451A_N5425A_7mm_60deg 1 2
r1 1 3 61.7
r2 2 4 61.7
c10 3 17 .15f
c11 4 17 .15f
c1 17 5 660.2f
c7 4 9 660.2f
l1 5 6 5.8n
l10 9 10 5.8n
r3 6 3 34.4
r16 10 17 34.4
csrc1 3 7 0f
l2 7 8 276n
r4 8 4 .001
c4 17 11 197.2f
c6 4 15 197.2f
l6 11 12 .34n
l9 15 16 .34n
r6 12 3 .001
r15 16 17 .001
c5 3 13 7.75f
l13 13 14 0n
r5 14 4 46.7
r19 3 17 25k
r10 4 17 25k
r11 17 18 157.6
l7 18 0 .36n
l8 17 0 87.9u
ends

```

8 SPICE Models
 N5425A ZIF Head with N5451A Long-Wire ZIF Tip

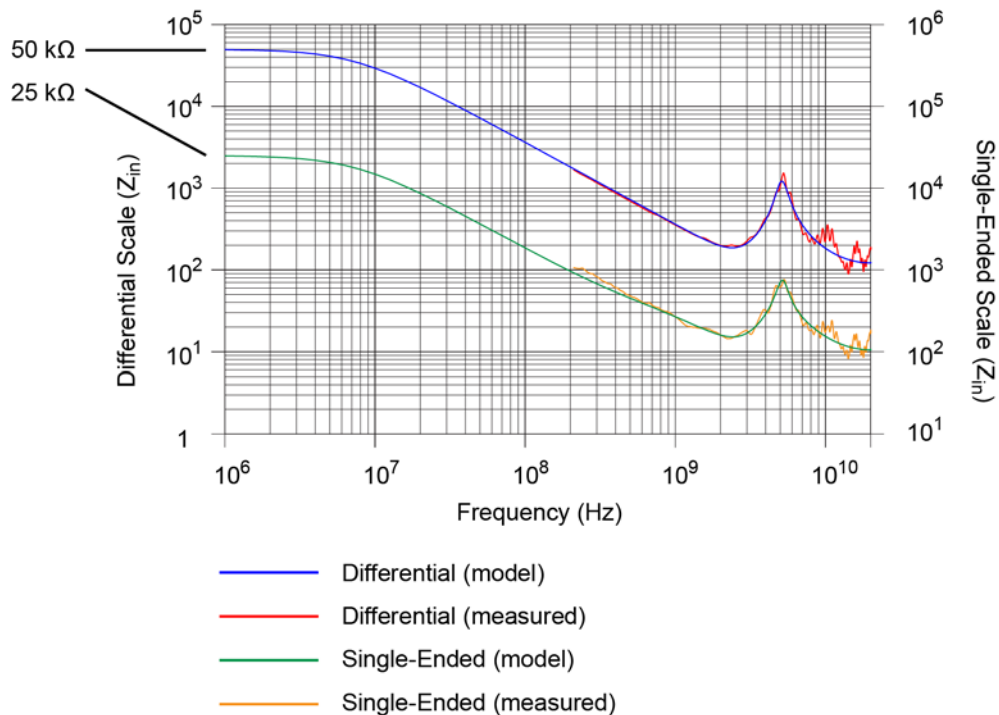

Figure 184 Measured and Modeled Data Matching for 7 mm Leads and 60° Spread

N5425A ZIF Head with N5451A Long-Wire ZIF Tip

**SPICE Deck with
N5451A ZIF Tip
(11 mm Lead and 0° Spread)**

```

* Input impedance SPICE subckt for probe head listed.
.subckt N5451A_N5425A_11mm_0deg 1 2
r1 1 3 54.59
r2 2 4 54.59
c10 3 17 0
c11 4 17 0
c1 17 5 307f
c7 4 9 307f
l1 5 6 11.64n
l10 9 10 11.64n
r3 6 3 57.72
r16 10 17 57.72
csrc1 3 7 199.6f
l2 7 8 28n
r4 8 4 149
c4 17 11 57.53f
c6 4 15 57.53f
l6 11 12 5.03n
l9 15 16 5.03n
r6 12 3 80.8
r15 16 17 80.8
c5 3 13 51f
l13 13 14 2.48n
r5 14 4 .22
r19 3 17 25k
r10 4 17 25k
r11 17 18 112.5
l7 18 0 .08n
l8 17 0 41.4u
ends

```

8 SPICE Models
N5425A ZIF Head with N5451A Long-Wire ZIF Tip

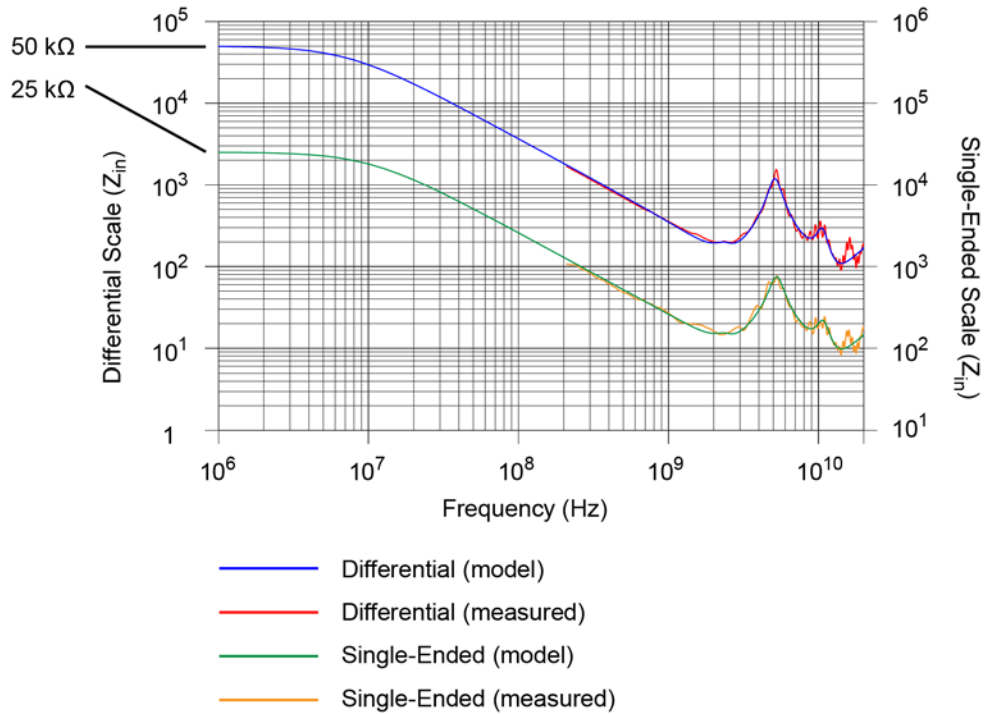

Figure 185 Measured and Modeled Data Matching for 11 mm Leads and 0° Spread

N5425A ZIF Head with N5451A Long-Wire ZIF Tip

**SPICE Deck with
N5451A ZIF Tip
(11 mm Lead and
60° Spread)**

```

* Input impedance SPICE subckt for probe head listed.
.subckt N5451A_N5425A_11mm_60deg 1 2
r1 1 3 74.80
r2 2 4 74.80
c10 3 17 3.02f
c11 4 17 3.02f
c1 17 5 236f
c7 4 9 236f
l1 5 6 17.51n
l10 9 10 17.51n
r3 6 3 195
r16 10 17 195
csrc1 3 7 217.3f
l2 7 8 28n
r4 8 4 42.8
c4 17 11 123.4f
c6 4 15 123.4f
l6 11 12 0n
l9 15 16 0n
r6 12 3 3.97
r15 16 17 3.97
c5 3 13 0f
l13 13 14 0n
r5 14 1.97
r19 3 17 25k
r10 4 17 25k
r11 17 18 32.3
l7 18 0 .59n
l8 17 0 5.69u
ends

```

8 SPICE Models

N5425A ZIF Head with N5451A Long-Wire ZIF Tip

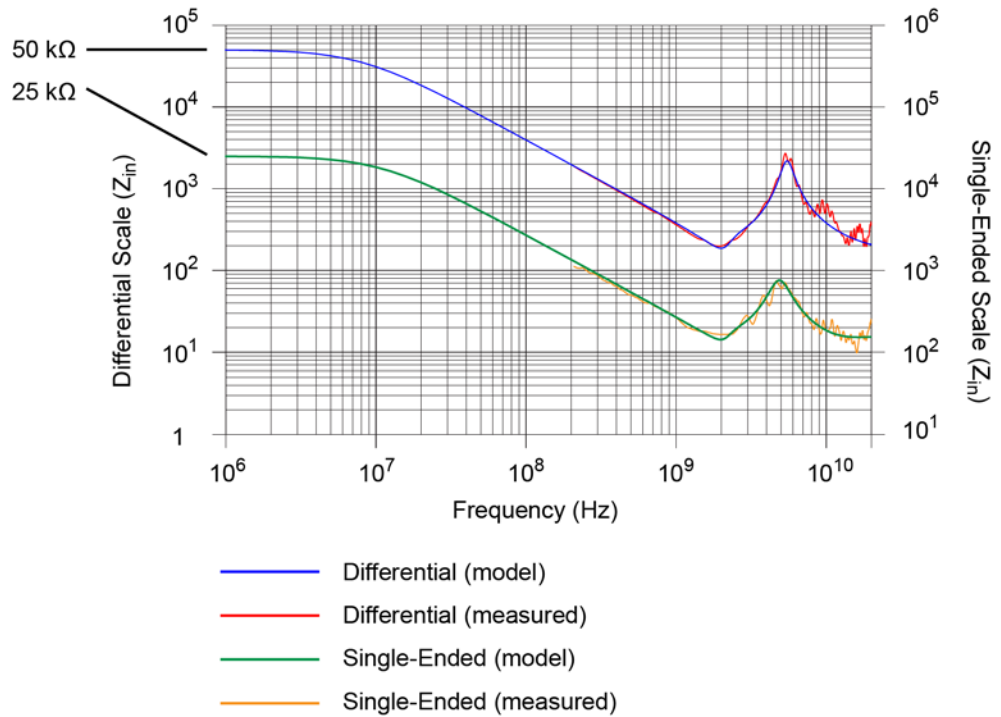
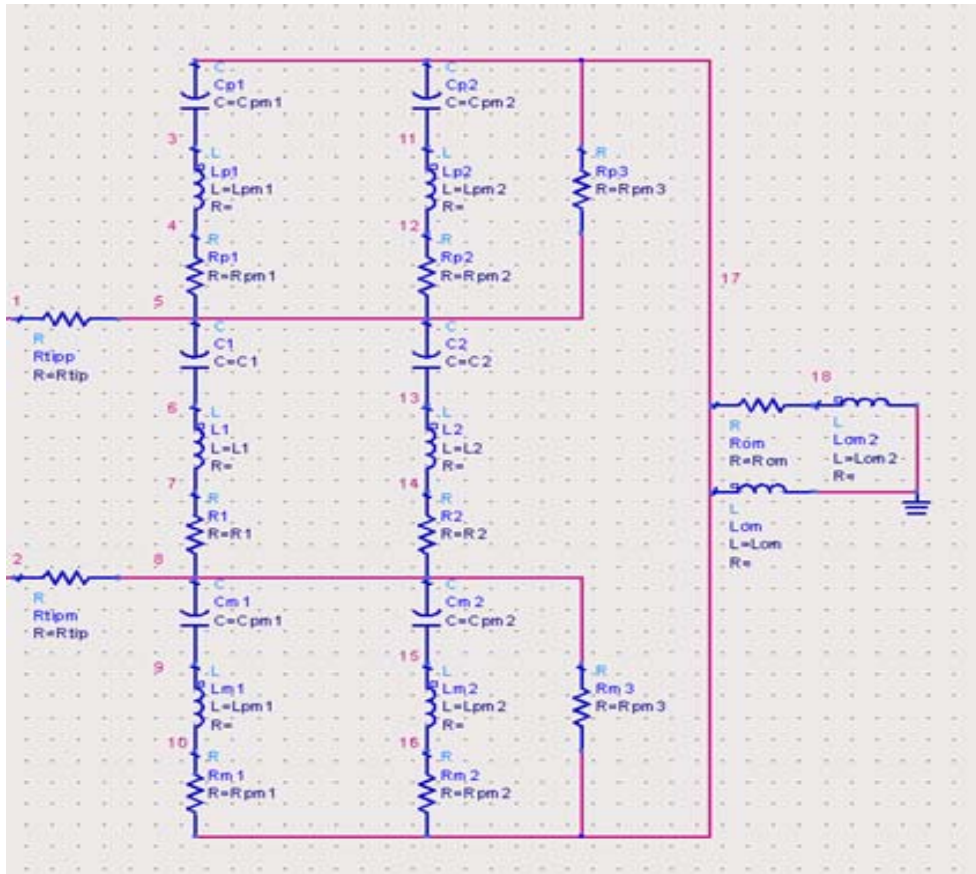

Figure 186 Measured and Modeled Data Matching for 11 mm Leads and 60° Spread

N2887A/N2888A Heads

Differential SPICE Input Impedance Model



8 SPICE Models

N2887A/N2888A Heads

```
.subckt N2887A_Differential 1 2
rtipp 1 5 1e-12
rtipm 2 8 1e-12
cp1 3 17 .174p
lp1 3 4 1.843n
    rp1 4 5 9.309
cm1 8 9 .174p
lm1 9 10 1.843n
rm1 10 17 9.309
c1 5 6 .101p
l1 6 7 2.844n
r1 7 8 14.645
cp2 17 11 .329p
lp2 11 12 .335n
rp2 12 5 18.747
cm2 8 15 .329p
lm2 15 16 .335n
rm2 16 17 18.747
c2 5 13 .00001p
l2 13 14 .505n
r2 14 8 45.82
rp3 17 5 25k
rm3 8 17 25k
rom 17 18 3.82e-8
lom2 18 0 .501n
lom 17 0 20.5u
.ends
```

Single-Ended SPICE Input Impedance Model

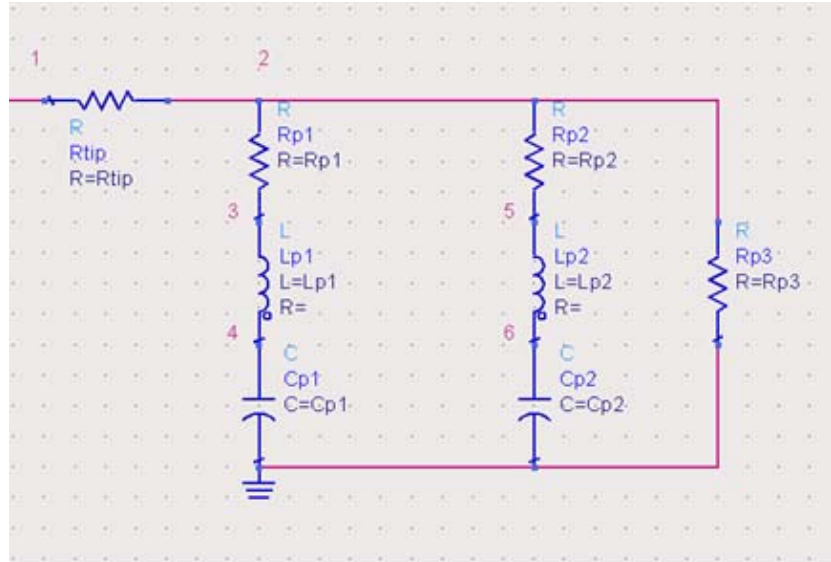

```
.subckt N2887A_SingleEnded 1
rtip 1 2 1e-12
rp1 2 3 12.480
lp1 3 4 1.525n
cp1 4 0 .407p
rp2 2 5 24.445
lp2 5 6 2.285n
cp2 6 0 .140p
rp3 2 0 25k
.ends
```

InfiniiMax I Heads

If damped wire accessories or longer mid-BW resistors (for solder-in probe heads) are used, they can be modeled by adding an RLC model in front of the appropriate probe head model and zeroing out the damping resistor in the probe head model.

There is one SPICE schematic for the differential probe heads and one SPICE schematic for the single-ended probe heads. The schematics have parameterized R, L, and C values that are given in the SPICE deck for the specific probe head. Additionally, an input impedance plot is given that shows the matching of the measured data to the modeled data. Matching is generally very good up to the specified BW of the probe head with the 7 GHz probe amp.

SPICE Model for Differential Heads

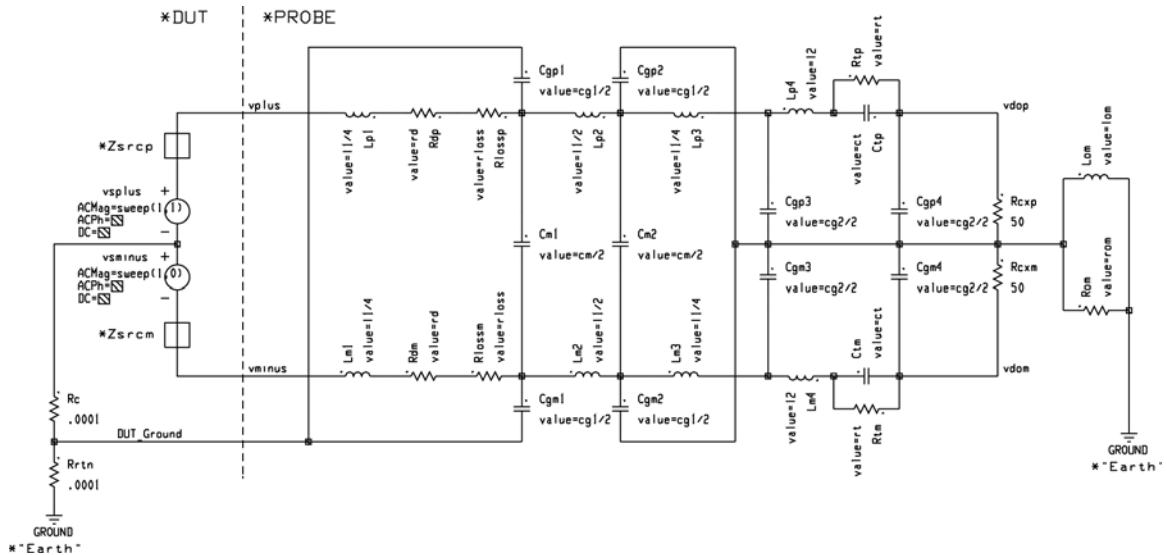

Figure 187 SPICE Model for Differential Probe Heads

R_{rtn} (Z_{rtn}) is dependent on connection from DUT ground to “Earth” ground. Most likely modeled by a parallel RL similar to $R_{om} || L_{om}$. Will have slight effect on single-ended input Z and no effect on differential input Z .

C_{gp1} and C_{gm1} represent C from probe tips to DUT ground near probe tips.

If using diff probe to probe single-ended signals:

- v_{plus} connected to DUT signal
- v_{minus} connected to DUT ground with means that $R_c = 0$ and $Z_{srcm} = 0$.
- Input impedance is defined to be v_{plus}/i (v_{splus})

If using diff probe to probe differential signals:

- Rc (or Zc) will depend on the DUT circuit
- vplus connected to DUT plus signal
- vminus connected to DUT minus signal.
- Input impedance is defined to be $(vplus/vminus) / i$ (vsplus)

SPICE Model for Single-Ended Heads

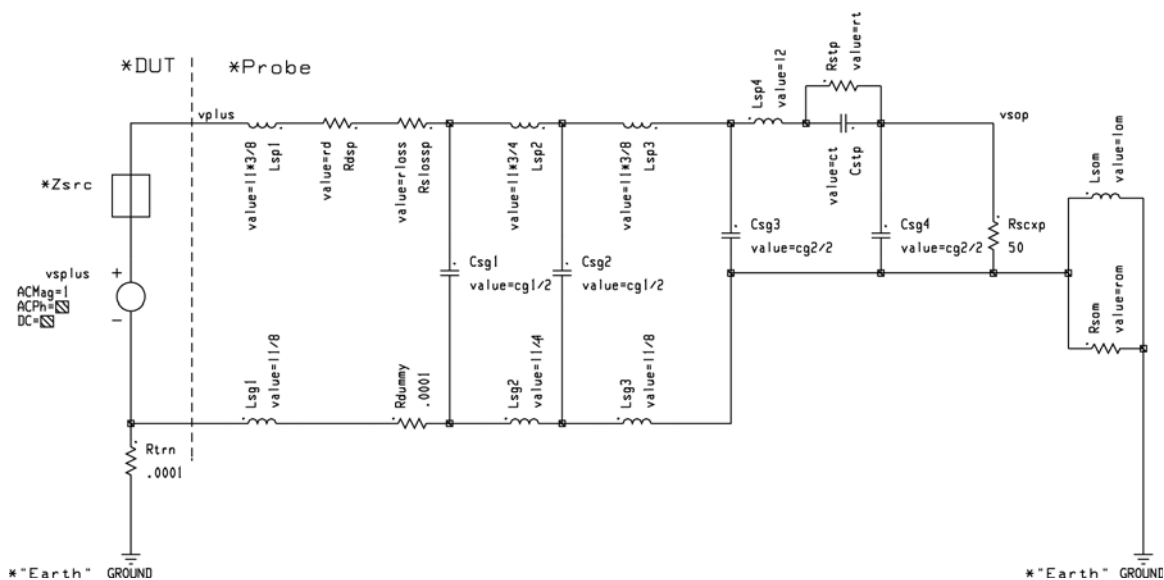

Figure 188 SPICE Model for Single-Ended Probe Heads

Rtn (Zrtn) is dependent on connection from DUT ground to “Earth” ground. Most likely modeled by a parallel RL similar to Rom || Lom. Will have slight effect on input Z.

Probe tip C to DUT ground lumped into Csgl since there is no damping R in ground path.

Input impedance is defined as $vplus/i(vplus)$.

SPICE Deck and Measured/Modeled Data Matching

E2675A Differential Browser Probe Head

```
.param rd=91 rt=25k rloss=10 rom=100
      l1=6.5n l2=2n lom=2u cm=80f
      cg1=120f cg2=320f ct=200f
```

```
vsminus %164 %vminus ACMag=sweep(1,0)
vsplus %vplus %164 ACMag=sweep(1,1)
Cgp1 %DUT_Ground %99 value=cg1/2
Cgp2 %122 %85 value=cg1/2
Cgm2 %84 %122 value=cg1/2
Cgm1 %95 %DUT_Ground value=cg1/2
Cm1 %99 %95 value=cm/2
Cgp3 %86 %122 value=cg2/2
Cm2 %85 %84 value=cm/2
Cgm4 %122 %vdom value=cg2/2
Cgm3 %122 %87 value=cg2/2
Cgp4 %vdop %122 value=cg2/2
Ctp %vdop %88 value=ct
Ctm %89 %vdom value=ct
Lm3 %84 %87 value=l1/4
Lp3 %86 %85 value=l1/4
Lm4 %89 %87 value=l2
Lp4 %86 %88 value=l2
Lp1 %118 %vplus value=l1/4
Lp2 %85 %99 value=l1/2
Lm1 %vminus %117 value=l1/4
Lm2 %95 %84 value=l1/2
Lom %122 %0 value=lom
Rrtn %DUT_Ground %0 .0001
Rc %164 %DUT_Ground .0001
Rlossp %99 %159 value=rloss
Rlossm %160 %95 value=rloss
Rdp %159 %118 value=rd
Rdm %117 %160 value=rd
Rtm %vdom %89 value=rt
Rtp %88 %vdop value=rt
Rcxp %vdop %122 50
Rcxm %122 %vdom 50
Rom %122 %0 value=rom
```



8 SPICE Models InfiniiMax I Heads

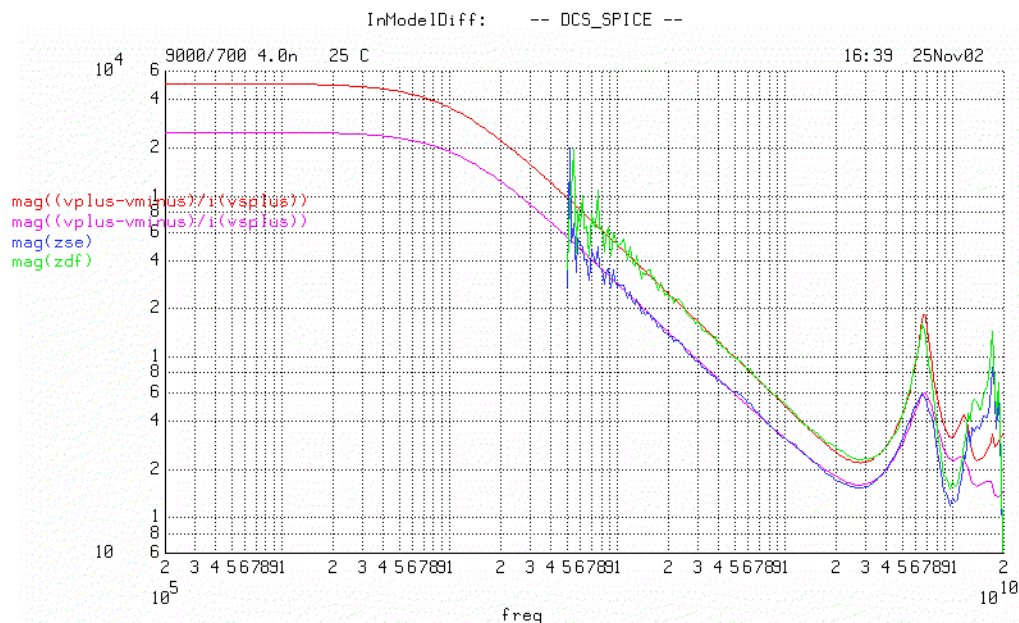

E2678A Differential Socket Tip Head

```
.param rd=82 rt=25k rloss=25 rom=200
      l1=4n l2=2n lom=2u cm=117f cg1=120f
      cg2=320f ct=200f
```

```
vsminus %164 %vminus ACMag=sweep(1,0)
vsplus %vplus %164 ACMag=sweep(1,1)
Cgp1 %DUT_Ground %99 value=cg1/2
Cgp2 %122 %85 value=cg1/2
Cgm2 %84 %122 value=cg1/2
Cgm1 %95 %DUT_Ground value=cg1/2
Cm1 %99 %95 value=cm/2
Cgp3 %86 %122 value=cg2/2
Cm2 %85 %84 value=cm/2
Cgm4 %122 %vdom value=cg2/2
Cgm3 %122 %87 value=cg2/2
Cgp4 %vdop %122 value=cg2/2
Ctp %vdop %88 value=ct
Ctm %89 %vdom value=ct
Lm3 %84 %87 value=l1/4
Lp3 %86 %85 value=l1/4
```



E2677A Differential Solder-In Head
 Data for full bandwidth with 91Ω resistor.

```
.param rd=91 rloss=18 rt=25k rom=250
      l1=4n l2=2n lom=2u cm=100f cg1=80f
      cg2=180f ct=200f
```

```
vsminus %164 %vminus ACMag=sweep(1,0)
vsplus %vplus %164 ACMag=sweep(1,1)
Cgp1 %DUT_Ground %99 value=cg1/2
Cgp2 %122 %85 value=cg1/2
Cgm2 %84 %122 value=cg1/2
Cgm1 %95 %DUT_Ground value=cg1/2
Cm1 %99 %95 value=cm/2
Cgp3 %86 %122 value=cg2/2
Cm2 %85 %84 value=cm/2
Cgm4 %122 %vdom value=cg2/2
Cgm3 %122 %87 value=cg2/2
Cgp4 %vdop %122 value=cg2/2
Ctp %vdop %88 value=ct
Ctm %89 %vdom value=ct
Lm3 %84 %87 value=l1/4
Lp3 %86 %85 value=l1/4
Lm4 %89 %87 value=l2
Lp4 %86 %88 value=l2
Lp1 %118 %vplus value=l1/4
Lp2 %85 %99 value=l1/2
Lm1 %vminus %117 value=l1/4
Lm2 %95 %84 value=l1/2
Lom %122 %0 value=lom
Rrtn %DUT_Ground %0 .0001
Rc %164 %DUT_Ground .0001
Rlossp %99 %159 value=rloss
Rlossm %160 %95 value=rloss
Rdp %159 %118 value=rd
Rdm %117 %160 value=rd
Rtm %vdom %89 value=rt
Rtp %88 %vdop value=rt
Rcxp %vdop %122 50
Rcxm %122 %vdom 50
Rom %122 %0 value=rom
```



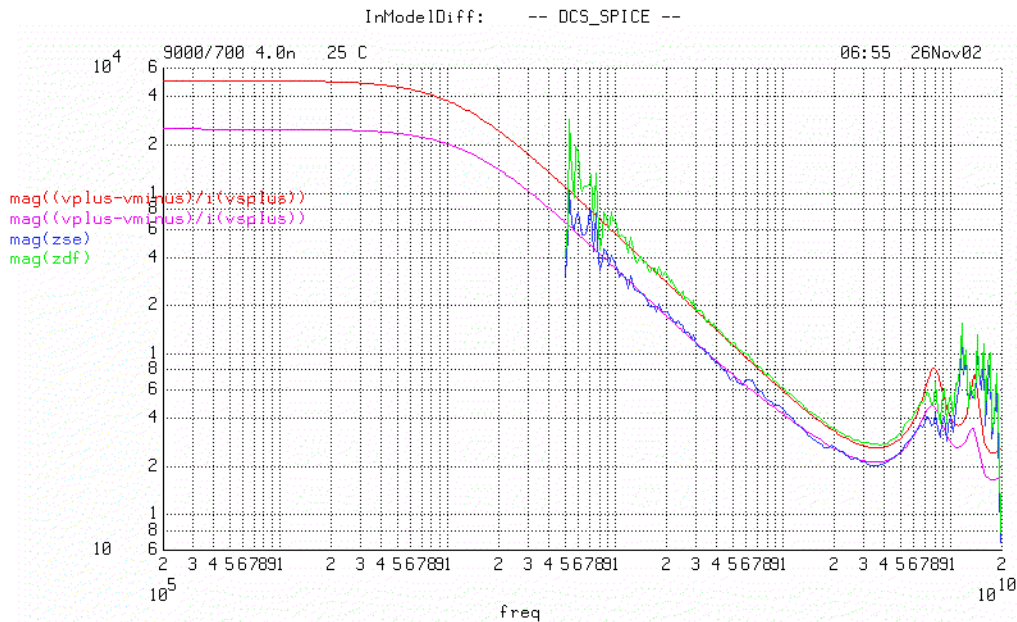

E2676A Single-Ended Browser Head

```
.param rd=82 rt=25k rom=100 rloss=25
    l1=3.5n l2=.5n lom=2u cg1=270f cg2=370f
    ct=200f
```

```
.ac dec 77 200k 19.7g
.options map
vsplus %130 %165 ACMag=1
Csg4 %vsop %134 value=cg2/2
Cstp %vsop %131 value=ct
Csg2 %138 %139 value=cg1/2
Csg3 %132 %134 value=cg2/2
Csg1 %137 %136 value=cg1/2
Lsp1 %141 %130 value=l1*3/8
Lsp2 %138 %137 value=l1*3/4
Lsg1 %165 %164 value=l1/8
Lsg2 %136 %139 value=l1/4
Lsom %134 %0 value=lom
Lsp4 %132 %131 value=l2
Lsp3 %132 %138 value=l1*3/8
Lsg3 %139 %134 value=l1/8
```



8 SPICE Models InfiniiMax I Heads

```
Rtrn %165 %0 .0001
Rdummy %164 %136 .0001
Rsllossp %137 %161 value=rloss
Rdsp %161 %141 value=rd
Rstp %131 %vsop value=rt
Rscxp %vsop %134 50
Rsom %134 %0 value=rom
```

InModelSe: -- DCS_SPICE --

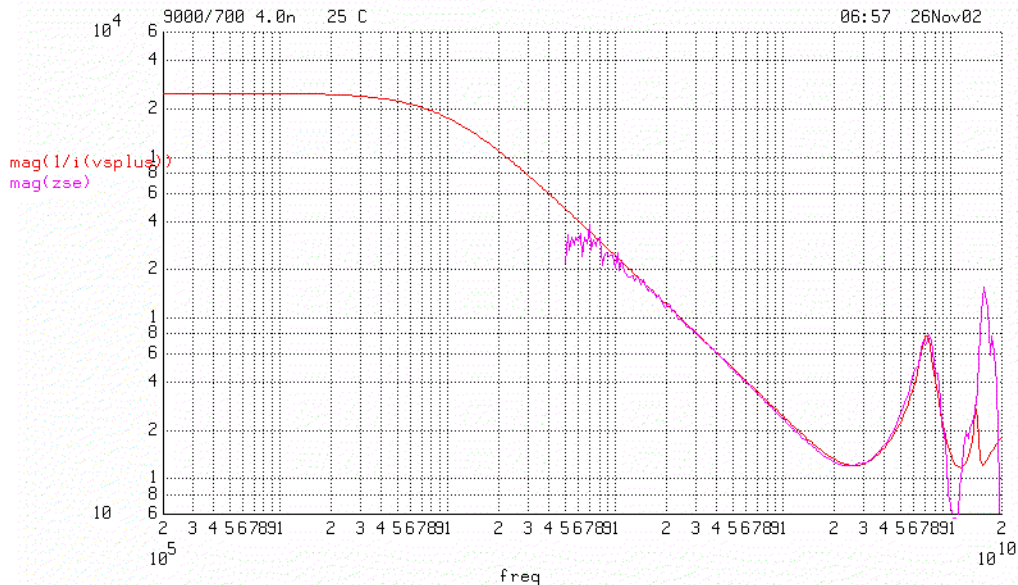

E2679A Single-Ended Solder-In Head

Data for full bandwidth with 91 Ω resistor.

```
.param rd=91 rt=25k rom=250 rloss=25
l1=3n l2=.5n lom=2u cg1=150f
cg2=300f ct=200f
```

```
.ac dec 77 200k 19.7g
.options map
vsplus %130 %165 ACMag=1
Csg4 %vsop %134 value=cg2/2
Cstp %vsop %131 value=ct
Csg2 %138 %139 value=cg1/2
```



8 **SPICE Models**
InfiniiMax I Heads

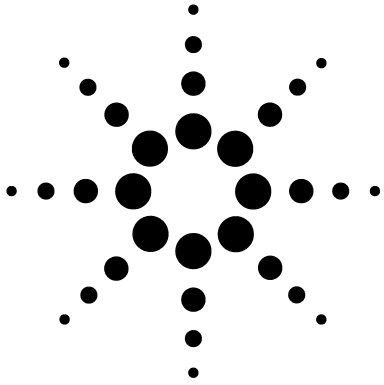

9

Replacement Parts

E2675A Differential Browser Probe Head	250
E2677A Differential Solder-In Probe Head	250
E2678A Differential Socketed Probe Head	251
E2679A Single-Ended Solder-in Probe Head	252
N5381A and N5382A Probe Heads	252
Other Accessories	253



E2675A Differential Browser Probe Head

Table 29 E2658A Kit

Description	Qty Supplied
Resistive tip (blue), 91 Ω	20
Ergonomic handle	1

E2677A Differential Solder-In Probe Head

Table 30 E2670A Kit

Description	Qty Supplied
91 Ω resistor for full bandwidth	20
150 Ω resistor for medium bandwidth	10
91 Ω resistor template	1
150 Ω resistor template	1

Table 31 Resistors

Description	Qty	Order From Vendor	Orderable Part Number
91 Ω resistor	1	BREL International	RMB16-910-JB
150 Ω resistor	1	BREL International	RMB16A-151-JB

E2678A Differential Socketed Probe Head

Table 32 E2671A Kit

Description	Qty Supplied
160Ω damped wire accessory	6
82Ω resistor for full bandwidth	48
Socket for 25 mil (25/1000 inch) square pins, female on both ends	4
25 mil female socket w/20 mil round male pin on other end	4
Heatshrink socket accessory	4
Header adapter, 91Ω	2
82Ω resistor template	1

Table 33 Resistors

Description	Qty	Order From Vendor	Orderable Part Number
82Ω resistor	1	Vishay	MBA0204AC8209GC100

E2679A Single-Ended Solder-in Probe Head

Table 34 Resistors

Description	Qty	Order From Vendor	Orderable Part Number
0 Ω resistor	1	BREL International	RMB16-000-JB
91 Ω resistor	1	BREL International	RMB16-910-JB

N5381A and N5382A Probe Heads

Table 35 Replacement Wire

Description	Qty	Order Part Number
0.005 steel wire and trim gauge (N5382A)	1	01169-21304
0.007 tin-plated nickel wire and trim gauge (N5381A)	1	01169-81301
0.005 tin-plated nickel wire and trim gauge (N5381A)	1	01169-21306

Other Accessories

Table 36 Accessories

Description	Vendor	Part Number	Qty
Probe Amplifier Ground Wire	—	01131-21301	1
Probe deskew and performance verification kit	Agilent	E2655A	1
160Ω damped wire accessory (01130-21302 34 each)	Agilent	E5381-82103	1
Header adapter kit for socketed differential probe head (01130-63201 10 each)	Agilent	01131-68703	1
Coupling tag for N5450B extreme temperature cable extension	Agilent	N5450-21201	1
SMA coaxial dc block	Inmet	#8037	1
SMA 6 dB coaxial attenuator	Inmet	#18AH-6	1
SMA 12 dB coaxial attenuator	Inmet	#18AH-12	1
SMA adjustable delay	ATM Microwave	#P1907	1
GPO-F to GPO-F adaptor for N5380B	Corning Gilbert Rosenberger	#A1A1-0001-03 #19K 109-K00 E4	2

9 Replacement Parts
Other Accessories

Index

Numerics

1143A, 10

A

accessories, 12
 damped wire, 75
 supplied, 12
 Agilent Technologies, contacting, 39
 altitude, 141
 attenuator kit, 20

B

browser, differential, 68
 browser, single-ended, 73

C

calibration
 failure, 37
 probe, 119
 probe with oscilloscope, 120
 channel identification rings, 10
 characteristics, 141
 cleaning, 10
 cleaning the probe, 10
 compatible oscilloscopes, 10

D

damped wire accessory, 75
 DC blocking caps, 23
 differential browser, 68
 differential probe head, 64, 66, 75
 dimensions, 141
 probe amp, 143

E

E2676A, 73
 E2677A, 64
 E2678A, 66, 75
 E2679A, 71
 environmental conditions, 141
 ergonomic handle, 50
 ESD tolerance, 138
 extreme temp, 17

F

full bandwidth probe, 64, 66, 71

G

general characteristics, 141

H

handle, 50
 humidity, 141

I

inspecting, 11

N

N1022A/B adapter, 10
 N2880A attenuators, 20
 N2881A CD blocking caps, 23
 N2884A, 57
 using, 83
 N2887A, 94
 N2888A, 94
 N5380B, 52
 N5381A, 46

N5382A, 49
 N5425A, 55
 N5426A, 55
 N5442A adapter, 10
 N5450B cable, 17
 N5451A, 60, 62

O

offset, 31
 operating environment, 141

P

performance test record, 214
 performance verification, 197
 pollution degree, 141
 power requirements, 141
 probe
 cleaning, 10
 dimensions, 143
 inspecting, 11
 service, 38
 probe amplifier, 27
 probe cable, 26
 probe calibration, 119
 probe handling, 25
 probe heads
 disconnecting, 25
 E2675A, 44
 E2676A, 44
 E2677A, 44
 E2678A, 44, 45
 E2679A, 44
 N5380B, 42
 N5381A, 42
 N5382A, 42
 N5425A, 42, 43

Index

R

recommended configuration, 42
resistance testing, 209
resistor
 dimensions, 104
returning for service, 38
robe's ground lead, 34

S

safety, 34
Safety Considerations, 34
safety information, 34
safety warnings, 34
service, 37
single-ended browser, 73
single-ended probe head, 71
slew rate requirements, 33
slew rates, 33
socketed differential probe, 66, 75
solder-in differential, 64
solder-in single-ended probe, 71
specifications, 135, 215

T

temperature, 141
temperature chamber, 17
testing
 input resistance, 209

V

velcro dots, 30

W

WEEE compliance, 136
weight, 141

Z

ZIF Tip

soldering, 78
ZIF tip
 N2884A, 43
 N5426A, 42
 N5451A, 43